



SPACEWIN[®]

Elegancy at its extremell

ELEGANTLY CRAFTED ALUMINIUM WINDOWS SYSTEM

PRODUCT CATALOGUE

VERSION 1.0

ABOUT US

SPACEBAR Group is a group of companies which are Dealing with elegantly Crafted Aluminium windows systems with the Brand name of SPACEWIN, Modern & Uniquely Designed Aluminium & SS Railing systems with the Brand Name of SPACERAIL and curtain wall & Glass facade systems with the brand name of SPACEARCH. Finest Design, Modern Concepts, Perfect Finishing, timely Delivery, Top of the town technical staff is the key parameter of the glorious success in last decade. In true sense, SPACEBAR Group is trying to beautify the world with its luxurious craftsmanship.

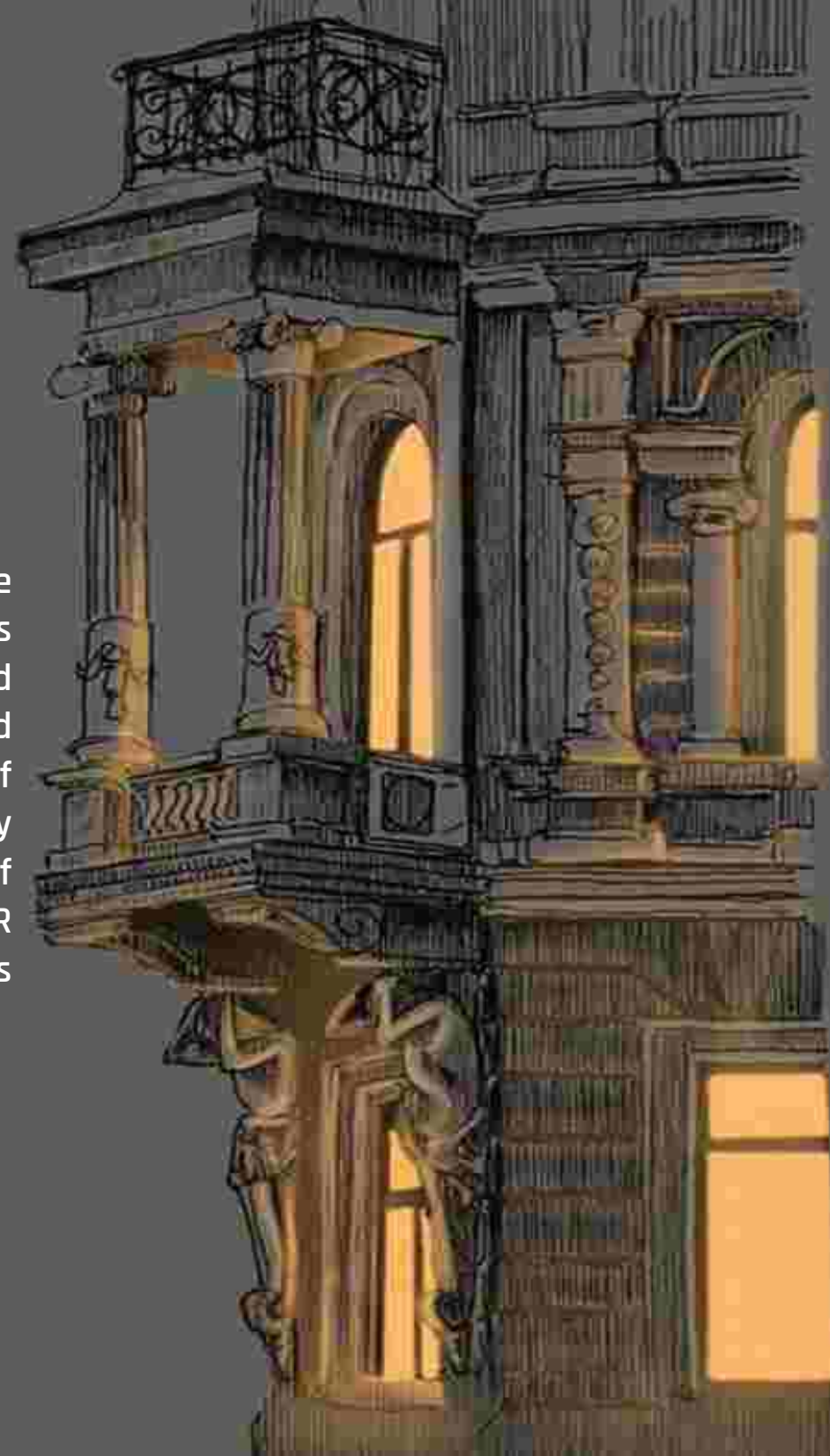

SPACEWIN®

Elegancy at its extreme!!

- O.S. OPERATOR —
- **SLIDING WINDOWS** —
- CASEMENT WINDOWS —
- CASEMENT DOOR —
- **PIVOT WINDOWS** —
- TILT & SLIDE — — TILT & TURN —
- **CURTAIN WALL** —
- SEMIUNITIZED —



SLIDING WINDOWS		992134	16	812676	25	914030	35	914354	47	CURTAIN WALL	
22MM		817915	16	817088	25	817091	35	914641	47	45MM	
551023	8	29MM		955110	25	817050	35	992095	47	914160	68
551024	8	914402	18	992312	25	817921	35	992036	47	914171	68
551022	8	914644	18	992091	25	50MM		914868	47	957035	68
551025	8	551009	18	992087	25	914351	38	PIVOT WINDOWS		914104	68
992093	8	914400	18	817072	25	914756	38	914775	52	50MM	
992134	8	914643	18	817089	25	914353	38	992165	52	551038	70
25MM		812520	18	992148	25	914520	38	992166	52	551037	70
955388	10	914699	18	914806	25	914352	38	992095	52	992098	70
955389	10	914401	18	914565	25	914797	38	914549	52	992097	70
955369	10	914519	18	992134	25	914564	38	914641	52	551041	70
992012	10	914405	19	992245	25	914549	39	914868	52	551042	70
992011	10	914642	19	37MM SLEEK		914354	39	992036	52	992099	70
955391	10	914897	19	812859	25	914641	39	O.S. OPERATOR		57MM	
955368	10	992222	19	992326	25	992095	39	992177	56	551026	72
955390	10	992111	19	CASEMENT WINDOWS		992036	39	992178	56	551027	72
914744	10	914900	19	30MM		914868	39	992095	56	812957	72
914401	10	914404	19	992108	30	CASEMENT DOOR		914549	56	812958	72
992088	10	817086	19	992058	30	40MM		914641	56	812959	72
26MM SLEEK		914698	19	992110	30	819022	44	914868	56	812960	72
955388	14	992134	19	992057	30	812659	44	992036	56	992090	72
955389	14	914806	19	32MM		817918	44	TILT & SLIDE		SEMI UNITIZED	
992265	14	914565	19	745611	32	819013	44	914774	60	67MM	
992012	14	817032	19	819080	32	819021	44	914775	60	551060	76
992011	14	914530	19	819081	32	819002	44	992109	60	551010	76
914401	14	29MM SLEEK		746510	32	819008	44	992095	60	551012	76
992268	14	812858	19	819082	32	914030	44	914549	60	551011	76
992266	14	992324	19	746509	32	817091	44	914641	60	819503	76
992267	14	37MM		40MM		817050	44	914868	60	968039	76
27MM		992248	24	914028	34	817921	44	992036	60	992004	76
812536	16	812514	24	914890	34	50MM		TILT & TURN		967053	77
955069	16	914742	24	819006	34	914774	46	914351	64	967054	77
914036	16	551015	24	819014	34	914775	46	914520	64	992003	77
817061	16	551016	24	819002	34	992214	46	914775	64	OFFICE PARTITION SYSTEM	
914037	16	955077	24	914891	34	992109	46	992109	64	OFFICE PARTITION	79
812683	16	967067	24	819013	34	914776	46	992095	65	STILE DOOR SYSTEM	80
992135	16	914668	25	819008	34	914797	46	914868	65		
817034	16	914409	25	819012	35	992208	46	914549	65		
914038	16	992173	25	817023	35	914777	46	992036	65		
992147	16	992086	25	914517	35	914549	47	914641	65		

SLIDING WINDOWS

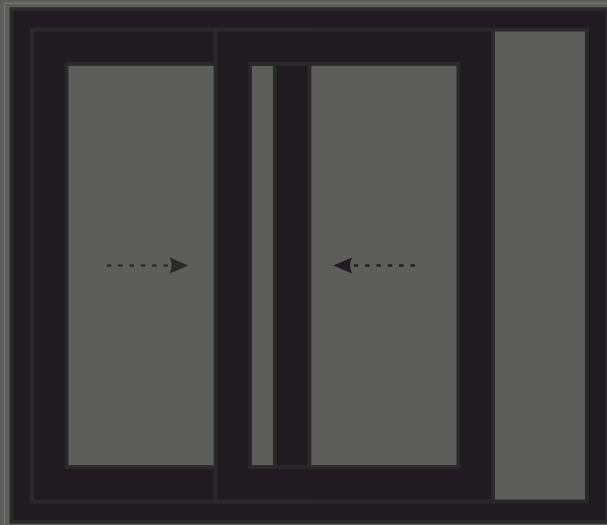

SLIDING WINDOWS

We give solutions to cover every type of opening with quality sliding windows designed for tropical conditions keeping in mind full water drainage and minimum air leakage. Our sliding window systems are designed for easy operation with a sturdy construction that gives a long and useful life. Excellent sealing characteristics and option of Double Glass units offer sound suppression with very low heat transfer across the windows which in turn give you excellent power savings over time. Designed for Ease of Fabrication with maximum on-floor productivity, these windows are the ideal fit for every quality conscious fabricator. The Euro groove system gives the end user full flexibility over type of hardware being used.

22mm | 25mm | 26mm_{SLEEK} | 27mm | 29mm | 29mm_{SLEEK} | 37mm | 37mm_{SLEEK}

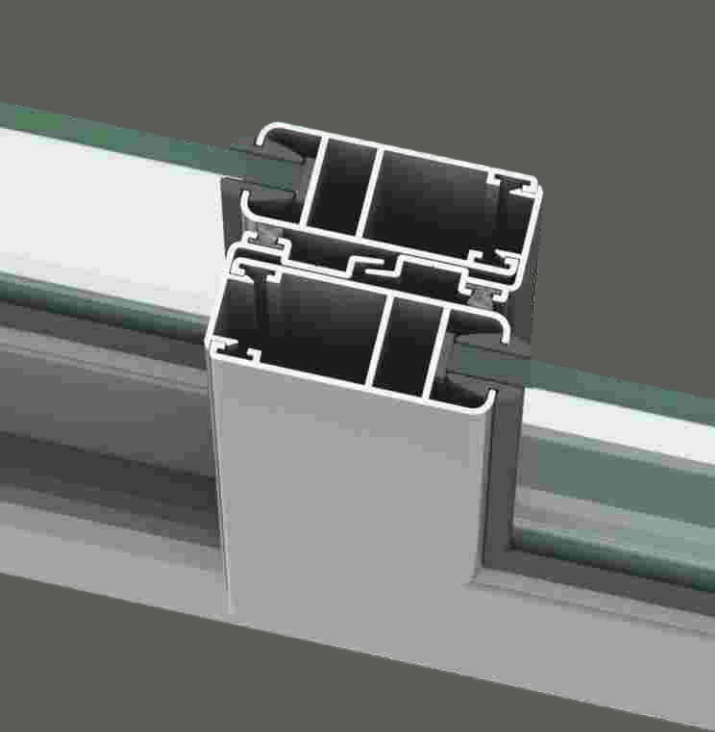

22mm
SLIDING WINDOWS

FEATURES

Shutter Depth	: 22mm
Locking Type	: Single Point Lock
Corner Details	: 45 degree cut with corner connector
Sealing Overlap	: Sealing with wool pile
S Glass Range	: 4 mm To 6 mm
Sightline with Shutter	: 82 mm
2 Track Depth	: 54 mm
3 Track Depth	: 84 mm
Window Height (Max.)	: 1530 mm
Finishes	: Powder/Wood/Anodizing
Hardware & WoolPile	: NA

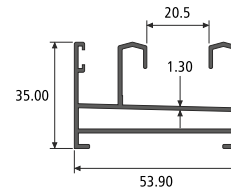

2 TRACK
SECTION NO. : 551023
Weight / Mtr : 0.800

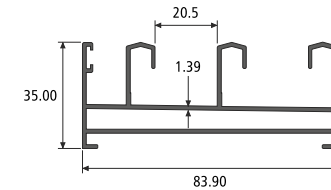

3 TRACK
SECTION NO. : 551024
Weight / Mtr : 1.130

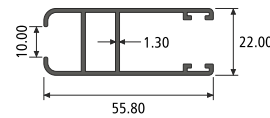

SHUTTER
SECTION NO. : 551022
Weight / Mtr : 0.550

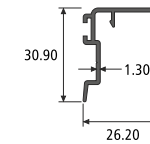

INTERLOCK
SECTION NO. : 551025
Weight / Mtr : 0.230

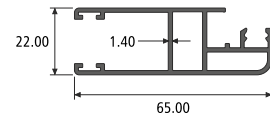

MOSQUITO SHUTTER
SECTION NO. : 992093
Weight / Mtr : 0.768

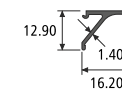

MOSQUITO CLIP
SECTION NO. : 992134
Weight / Mtr : 0.117

22mm TWO TRACK TWO SHUTTER ASSEMBLY

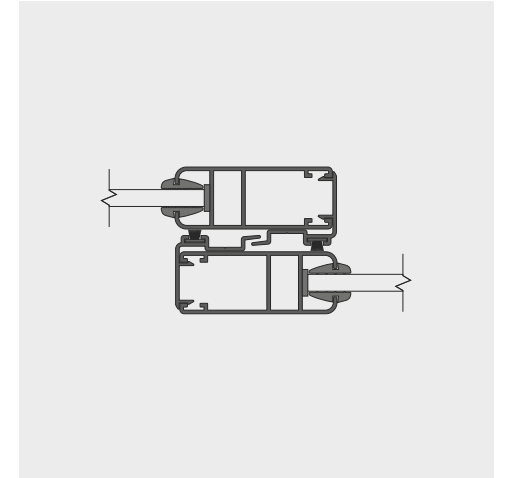
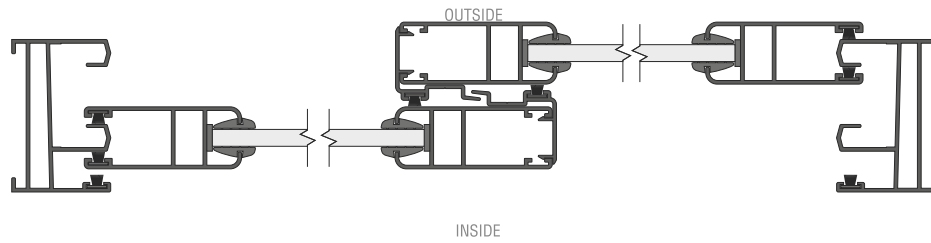
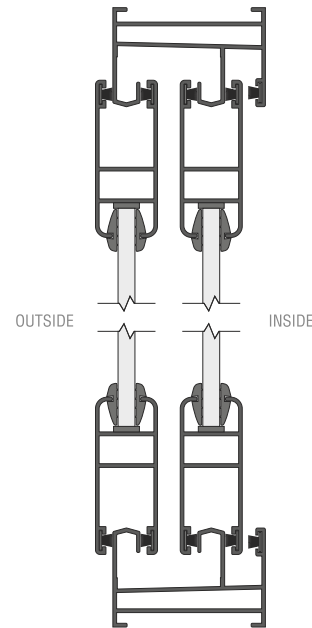
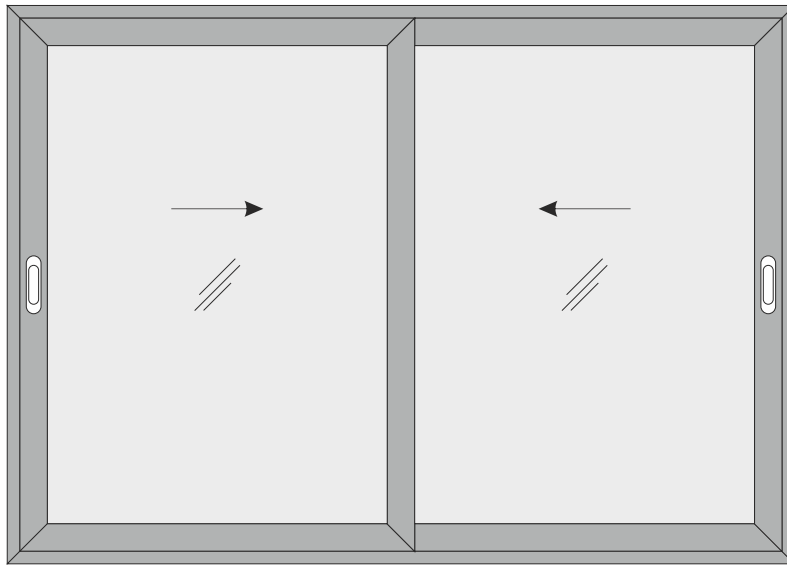

22mm INTERLOCK

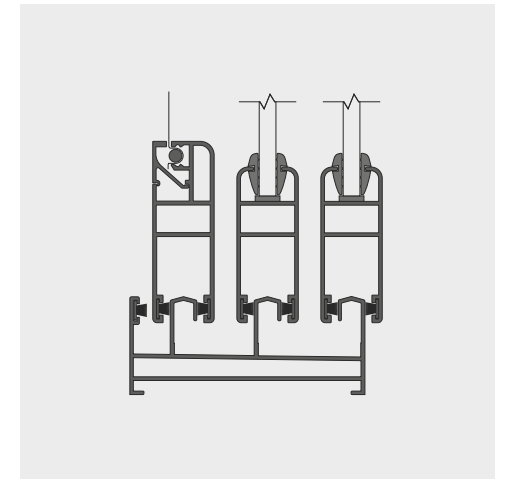

22mm THREE TRACK WITH MOSQUITO NET

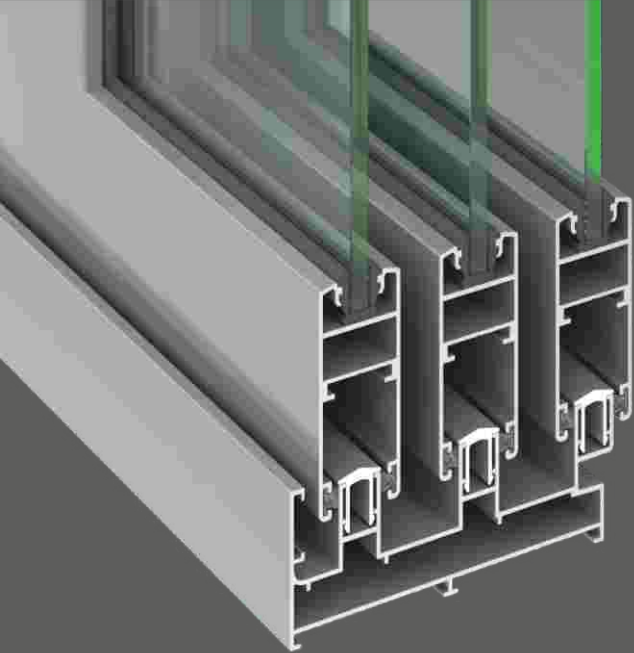

25mm
SLIDING WINDOWS

FEATURES

Shutter Depth	: 25mm
Locking Type	: Single & Multipoint Lock with Handle
Corner Details	: 45 degree cut with corner connector
Sealing Overlap	: 8mm (Sealing with wool pile)
S Glass Range	: 4 mm To 6 mm
Sightline with Shutter	: 95 mm
2 Track Depth	: 50 mm
3 Track Depth	: 86 mm
Window Height (Max.)	: 2100 mm
Finishes	: Powder/Wood/Anodizing
Hardware & WoolPile	: SCHLEGEL GIESSE

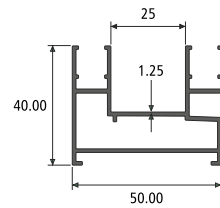

2 TRACK
SECTION NO. : 955388
Weight / Mtr : 0.795

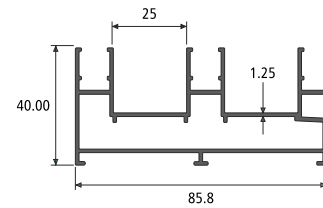

3 TRACK
SECTION NO. : 955389
Weight / Mtr : 1.240

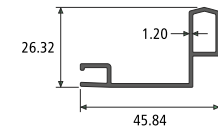

MESH TRACK
SECTION NO. : 955369
Weight / Mtr : 0.355

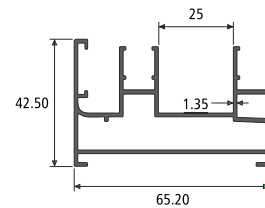

2 TRACK WITH LEG
SECTION NO. : 992012
Weight / Mtr : 1.015

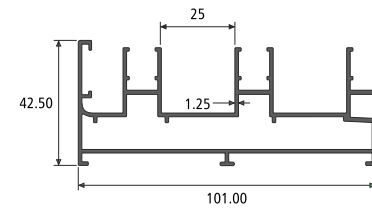

3 TRACK WITH LEG
SECTION NO. : 992011
Weight / Mtr : 1.450

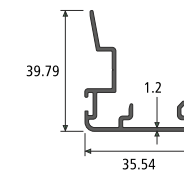

INTERLOCK
SECTION NO. : 955391
Weight / Mtr : 0.370

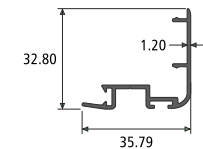

MOSQUITO INTERLOCK
SECTION NO. : 955368
Weight / Mtr : 0.310

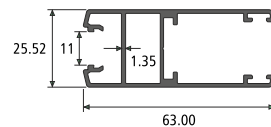

SHUTTER
SECTION NO. : 955390
Weight / Mtr : 0.750

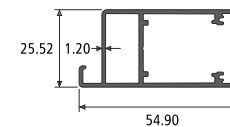

MOSQUITO SHUTTER
SECTION NO. : 914744
Weight / Mtr : 0.635

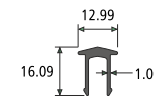

RAIL TRACK
SECTION NO. : 914401
Weight / Mtr : 0.148

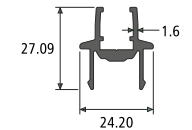

MATING
SECTION NO. : 992088
Weight / Mtr : 0.396

25mm THREE TRACK THREE SHUTTER ASSEMBLY

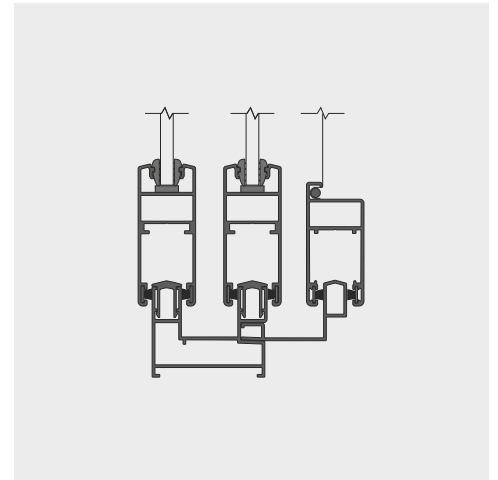
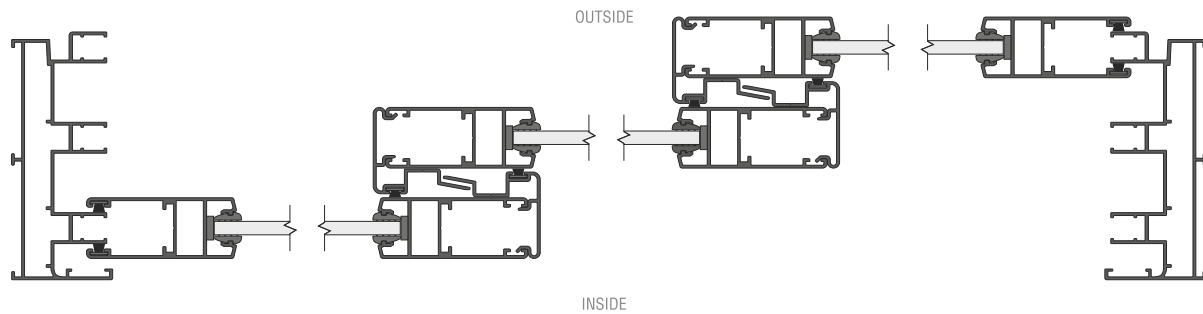
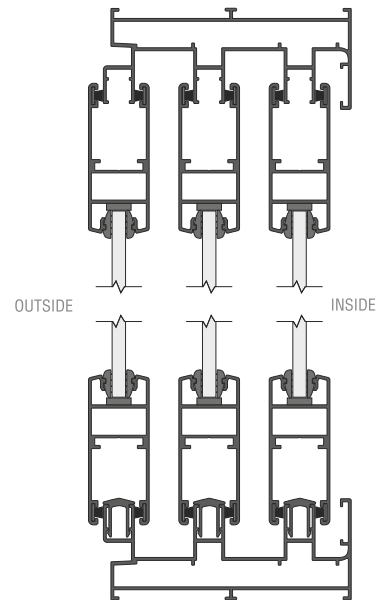
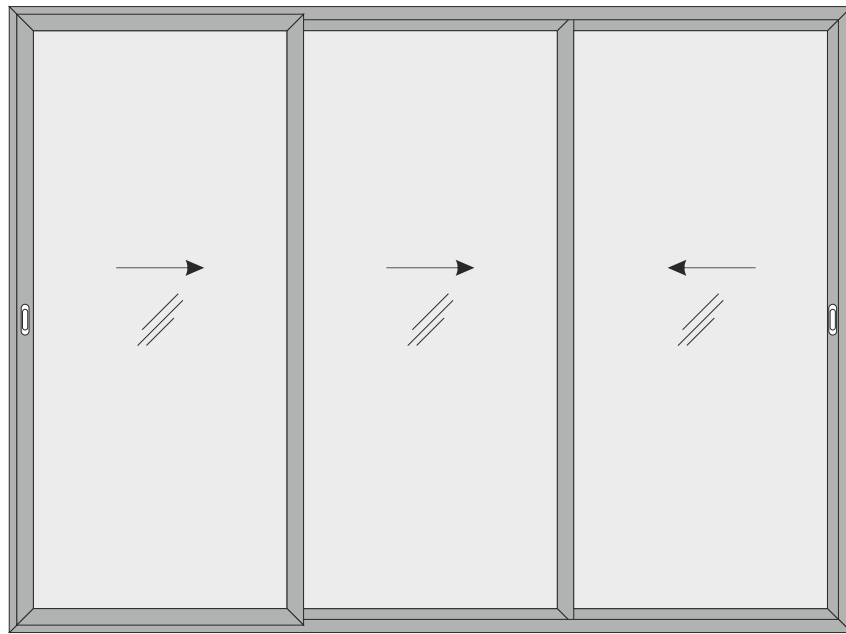

25mm MESH TRACK

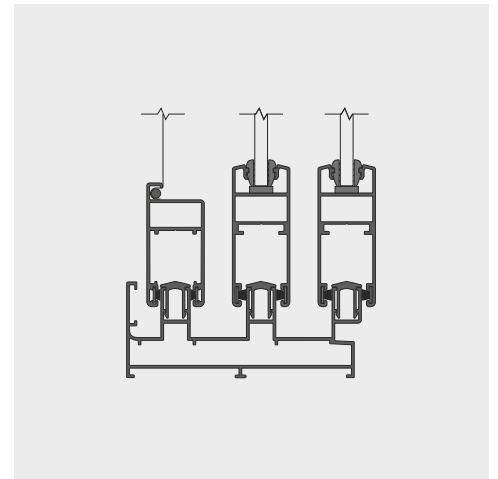

25mm THREE TRACK WITH MOSQUITO

25mm TWO TRACK FOUR SHUTTER ASSEMBLY

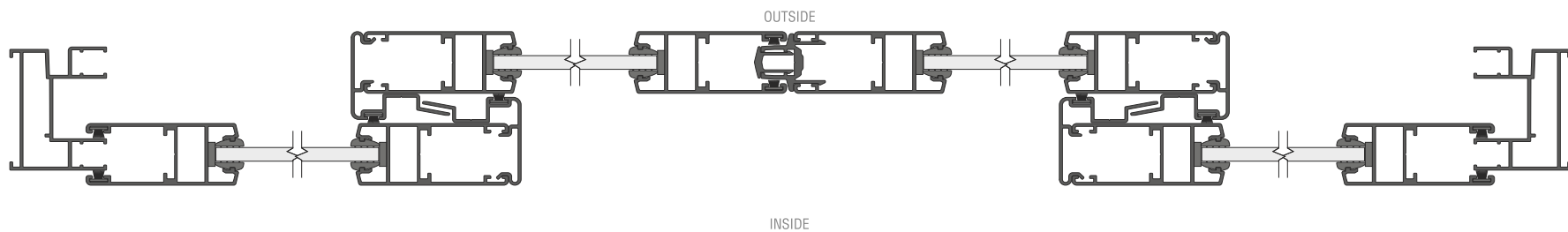
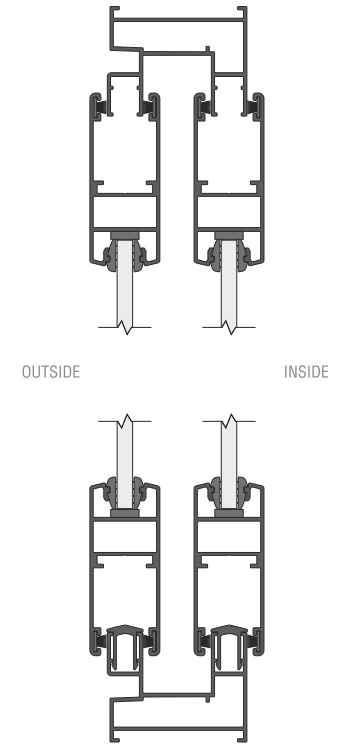
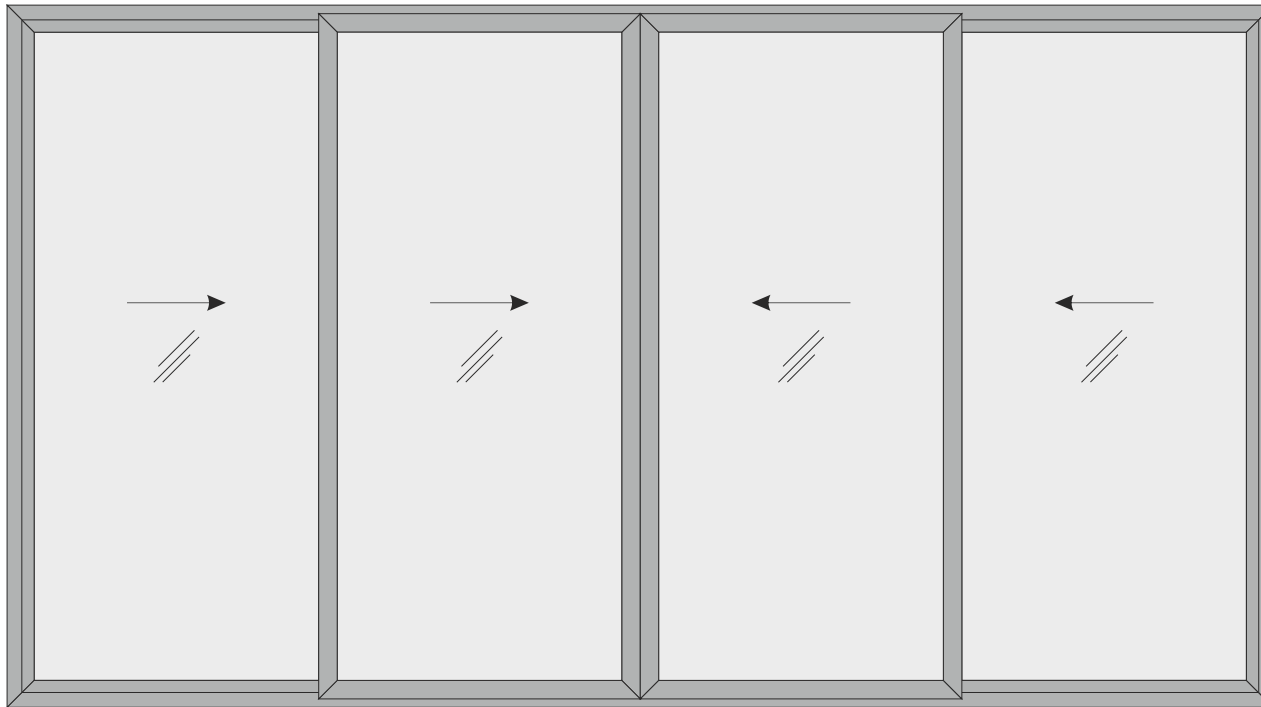

SPACEWIN®
Elegancy at its extreme!!

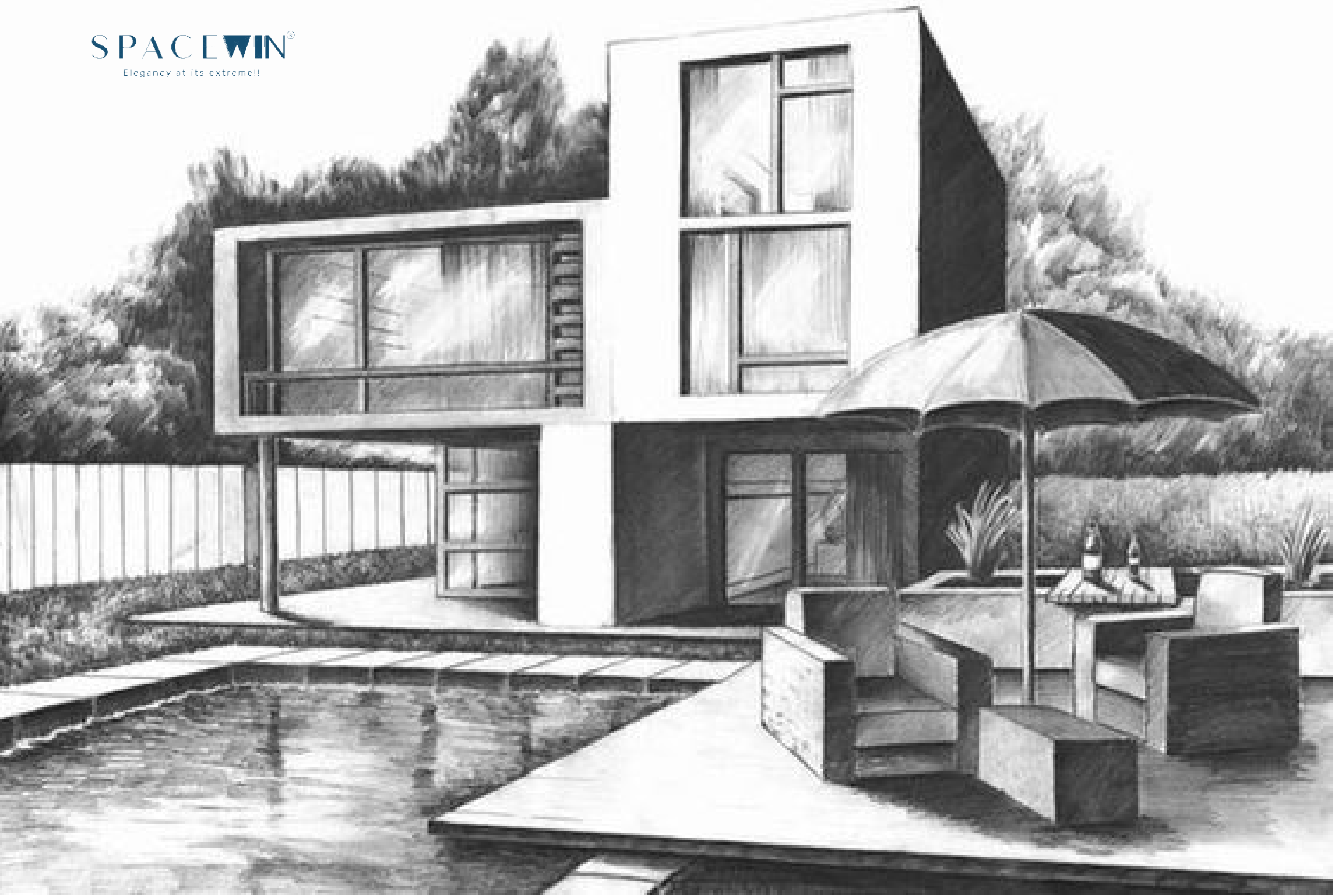

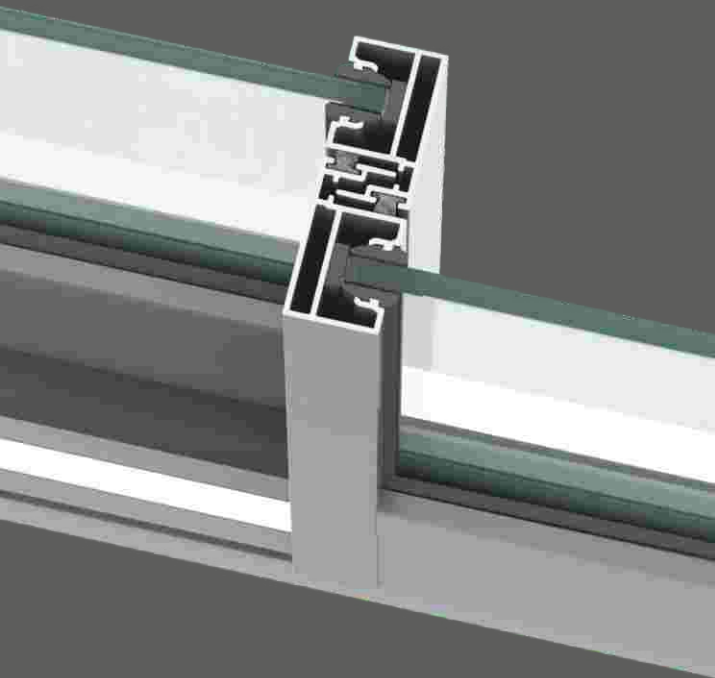

26mm^{SLEEK} SLIDING WINDOWS

FEATURES

Shutter Depth	: 26mm
Locking Type	: Single Point Lock
Corner Details	: 90 degree
Sealing Overlap	: 9 mm (Sealing with wool pile)
S Glass Range	: 4 mm To 6 mm
Sightline with Shutter	: 87 mm
2 Track Depth	: 50 mm
3 Track Depth	: 86 mm
Window Height (Max.)	: 1830 mm
Finishes	: Powder/Wood/Anodizing
Hardware & WoolPile	: SCHLEGEL GIESSE

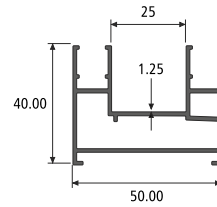

2 TRACK
SECTION NO. : 955388
Weight / Mtr : 0.795

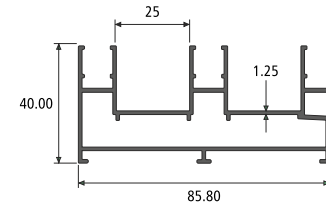

3 TRACK
SECTION NO. : 955389
Weight / Mtr : 1.240

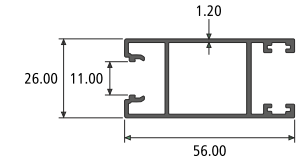

HANDLE
SECTION NO. : 992265
Weight / Mtr : 0.694

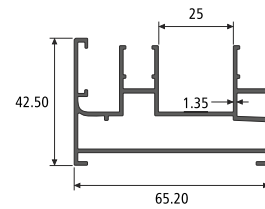

2 TRACK
SECTION NO. : 992012
Weight / Mtr : 1.015

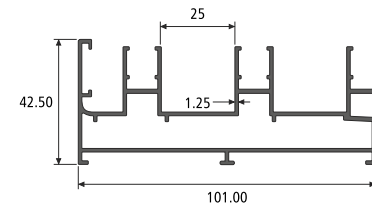

3 TRACK
SECTION NO. : 992011
Weight / Mtr : 1.450

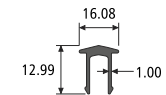

RAIL TRACK
SECTION NO. : 914401
Weight / Mtr : 0.148

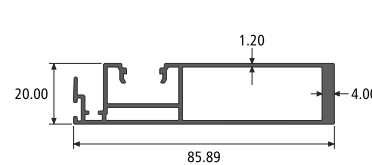

REINFORCEMENT INTERLOCK
SECTION NO. : 992268
Weight / Mtr : 0.975

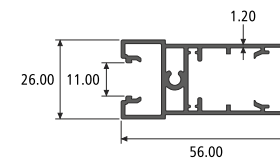

TOP & BOTTOM
SECTION NO. : 992266
Weight / Mtr : 0.753

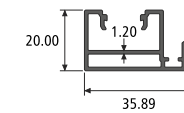

INTERLOCK
SECTION NO. : 992267
Weight / Mtr : 0.460

26mm TWO TRACK TWO SHUTTER ASSEMBLY

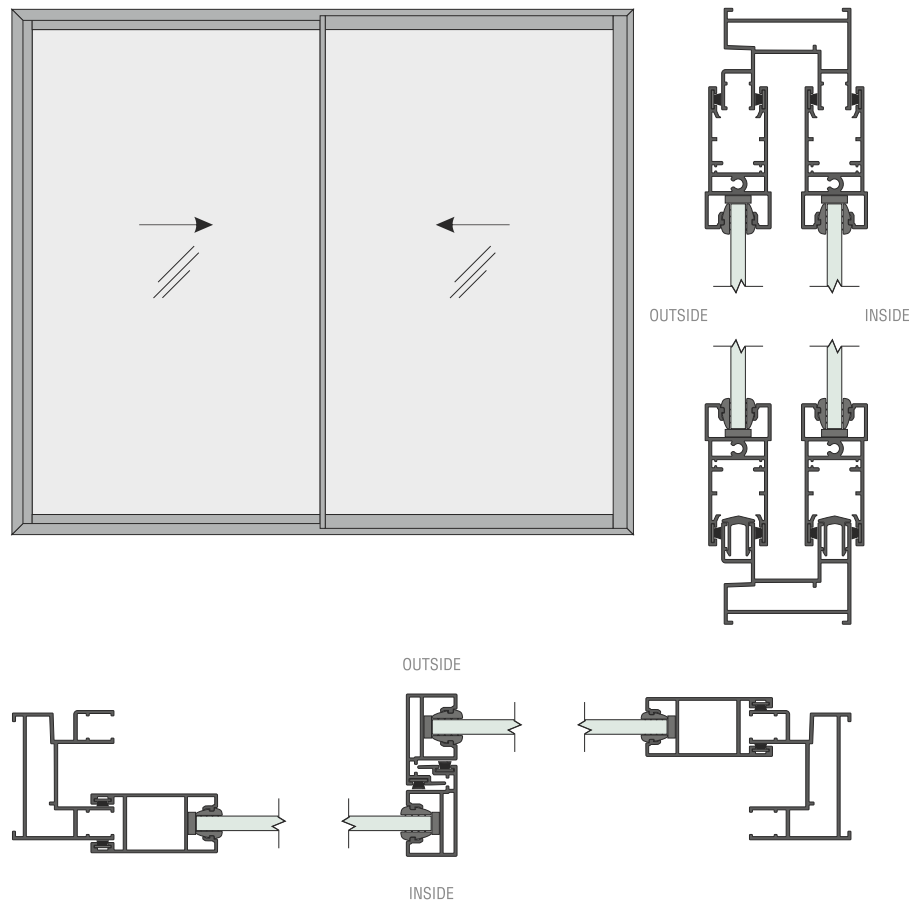

26mm THREE TRACK THREE SHUTTER ASSEMBLY

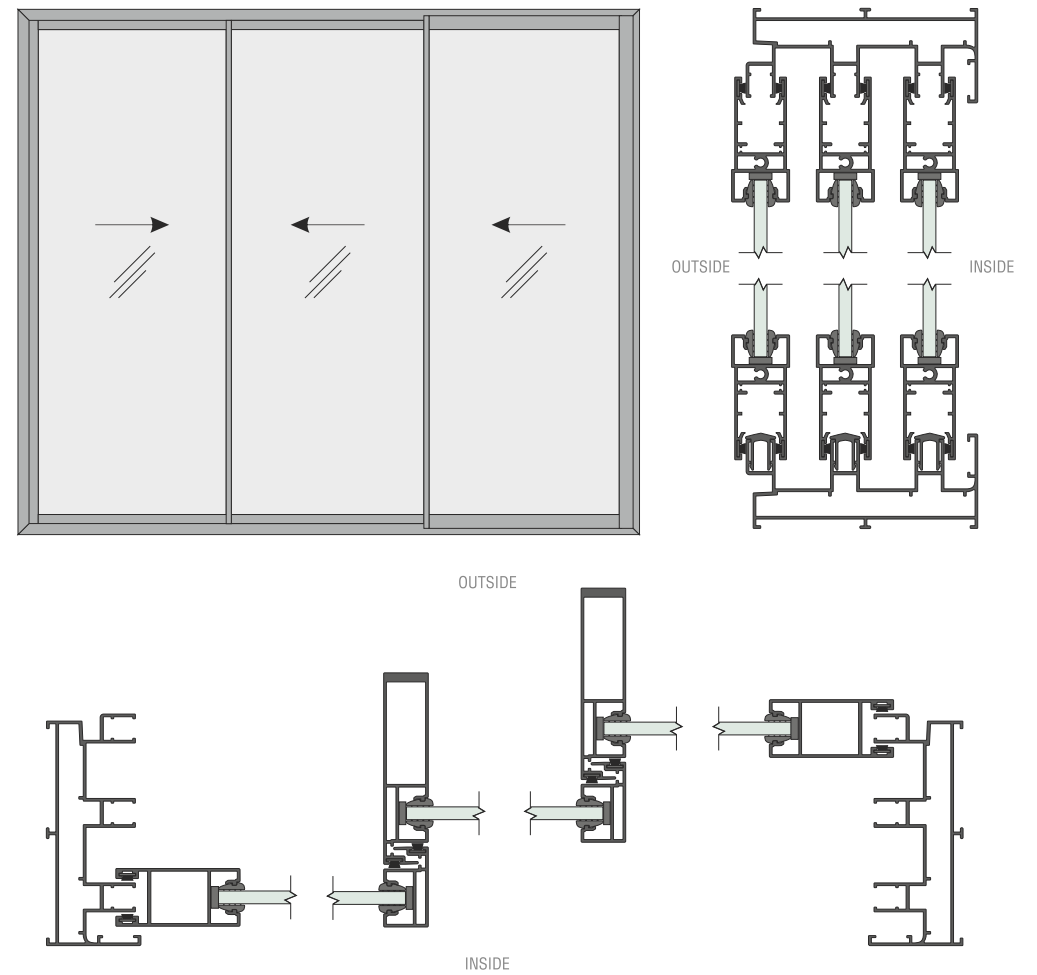

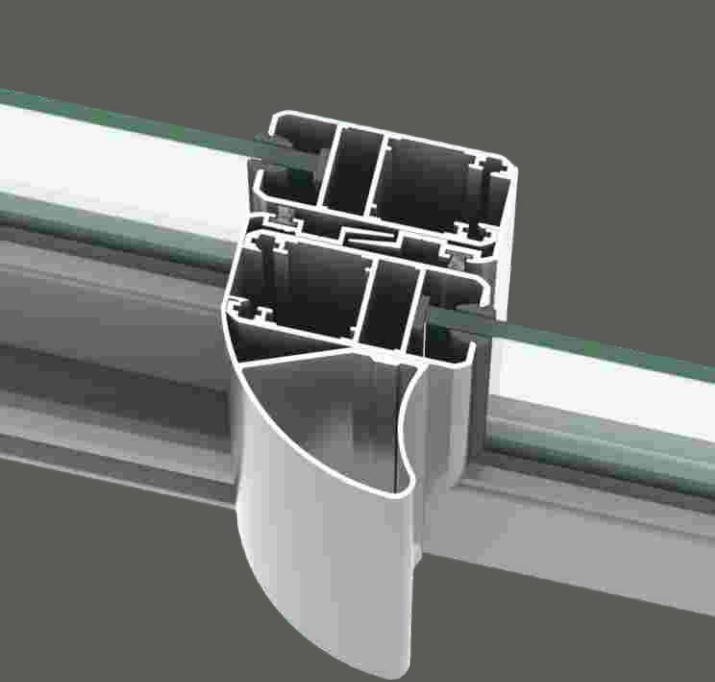

27mm
SLIDING WINDOWS

FEATURES

Shutter Depth	: 27mm
Locking Type	: Single & Multipoint Lock with Champion Plus
Corner Details	: 45 degree cut with corner connector
Sealing Overlap	: 11mm (Sealing with wool pile)
Single Glass Range	: 4 / 5 / 6 mm
Double Glass Range	: 18mm
Laminated Glass	: NA
Sightline with Shutter	: 99mm
2 Track Depth	: 40mm
3 Track Depth	: 75mm
Window Height (Max.)	: 21
Finishes	:
Hardware & WoolPile	:

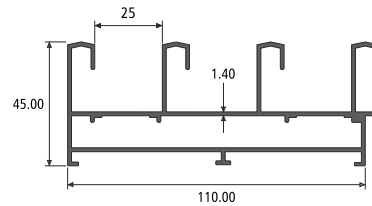

4 TRACK
SECTION NO. : 812536
Weight / Mtr : 1.765

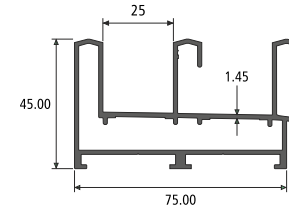

3 TRACK
SECTION NO. : 955069
Weight / Mtr : 1.405

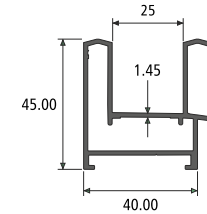

2 TRACK
SECTION NO. : 914036
Weight / Mtr : 0.873

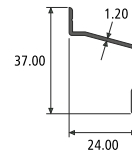

RAIN TRACK
SECTION NO. : 817061
Weight / Mtr : 0.195

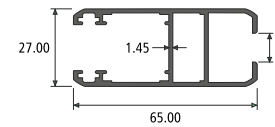

SGU SHUTTER
SECTION NO. : 914037
Weight / Mtr : 0.863

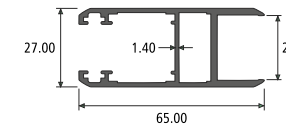

DGU SHUTTER
SECTION NO. : 812683
Weight / Mtr : 0.904

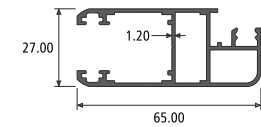

MOSQUITO SHUTTER
SECTION NO. : 992135
Weight / Mtr : 0.824

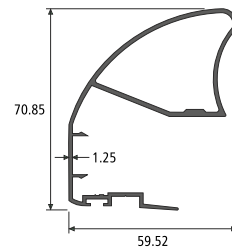

REINFORCEMENT INTERLOCK
SECTION NO. : 817034
Weight / Mtr : 0.920

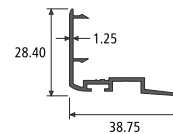

INTERLOCK
SECTION NO. : 914038
Weight / Mtr : 0.273

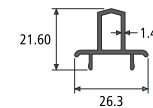

MATING PROFILE
SECTION NO. : 992147
Weight / Mtr : 0.263

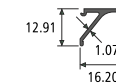

MOSQUITO CLIP
SECTION NO. : 992134
Weight / Mtr : 0.117

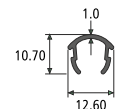

SHUTTER CAP
SECTION NO. : 817915
Weight / Mtr : 0.083

27mm TWO TRACK TWO SHUTTER ASSEMBLY

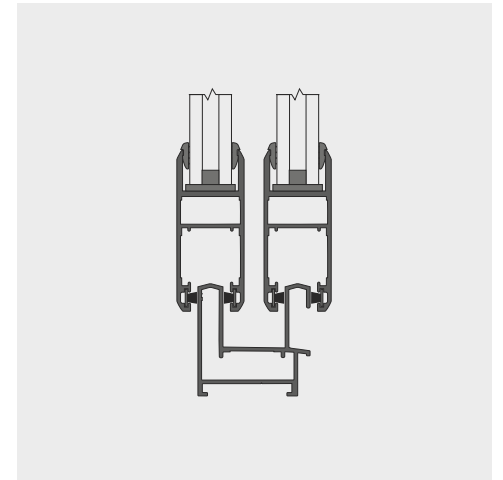
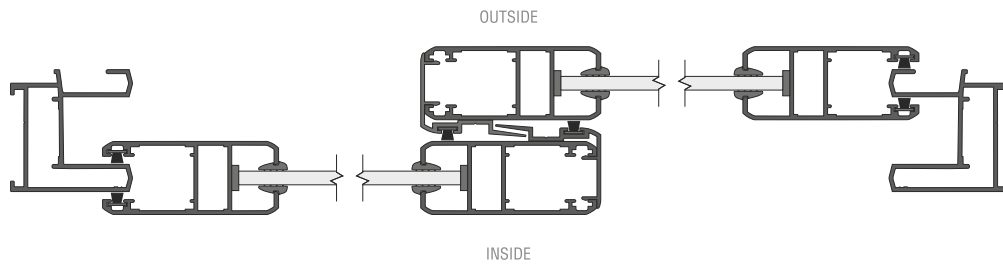
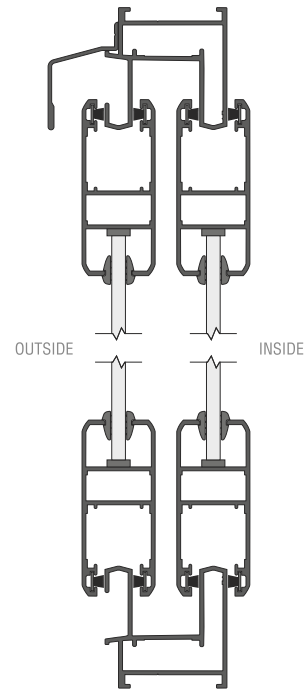
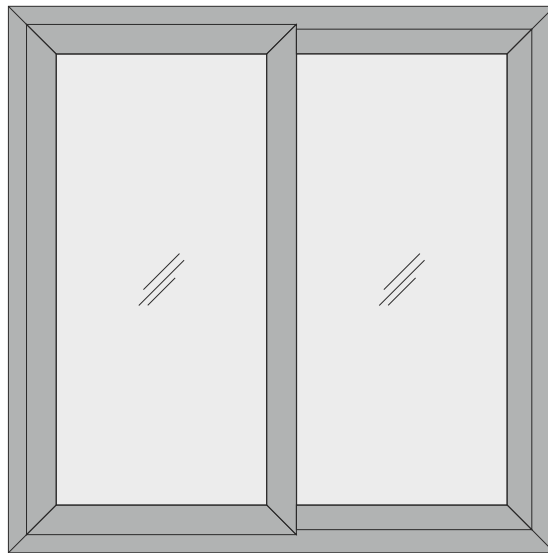

27mm DGU

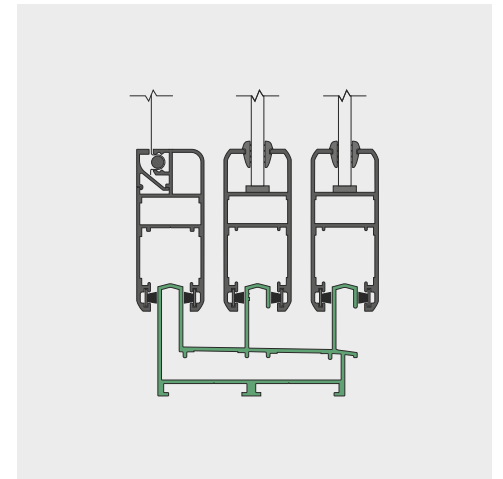

**27mm THREE TRACK
WITH MOSQUITO**

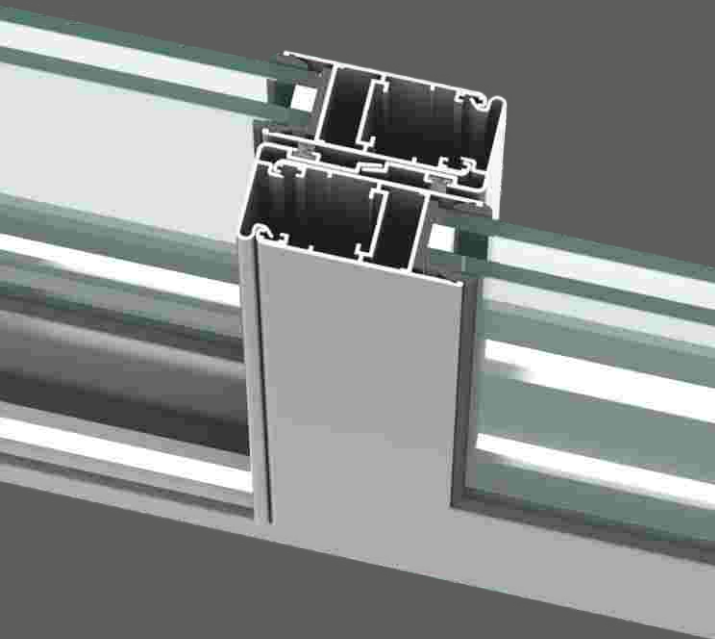

29mm / 29mm SLEEK
SLIDING WINDOWS

FEATURES

Shutter Depth	: 29mm
Locking Type	: Single&Multipoint Lock with Handle
Corner Details	: 45 degree cut with corner connector
Sealing Overlap	: 8mm (Sealing with wool pile)
S Glass Range	: 5 mm To 20 mm
Sightline with Shutter	: 104 mm
2 Track Depth	: 50 mm
3 Track Depth	: 86 mm
Window Height (Max.)	: 2440 mm
Finishes	: Powder/Wood/Anodizing
Hardware & WoolPile	: SCHLEGEL GIESSE

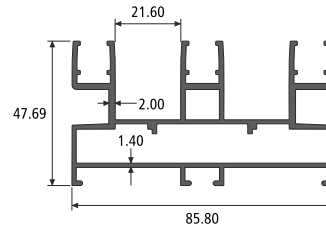

3 TRACK
SECTION NO. : 914402
Weight / Mtr : 1.724

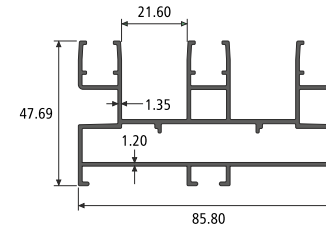

3 TRACK LIGHT
SECTION NO. : 914644
Weight / Mtr : 1.420

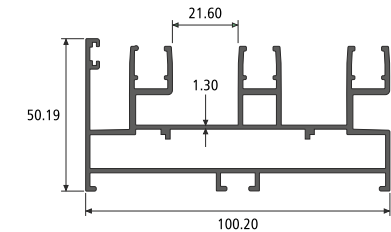

3 TRACK WITH LEG
SECTION NO. : 551009
Weight / Mtr : 1.969

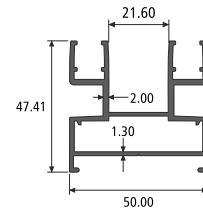

2 TRACK
SECTION NO. : 914400
Weight / Mtr : 1.100

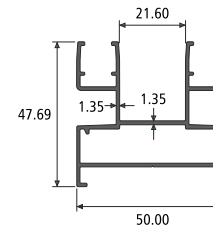

2 TRACK LIGHT
SECTION NO. : 914643
Weight / Mtr : 0.865

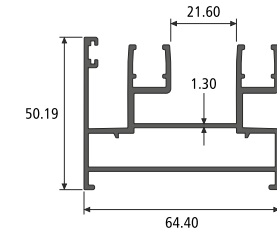

2 TRACK WITH LEG
SECTION NO. : 812520
Weight / Mtr : 1.325

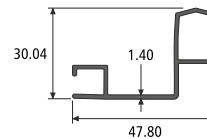

FLY MESH TRACK
SECTION NO. : 914699
Weight / Mtr : 0.427

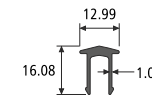

RAIL TRACK
SECTION NO. : 914401
Weight / Mtr : 0.148

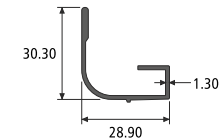

RAIN TRACK
SECTION NO. : 914519
Weight / Mtr : 0.283

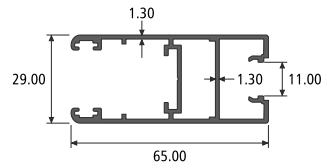

SGU SHUTTER
SECTION NO. : 914405
Weight / Mtr : 0.890

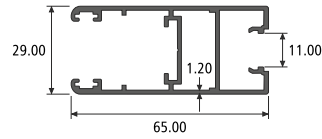

SGU SHUTTER LIGHT
SECTION NO. : 914642
Weight / Mtr : 0.815

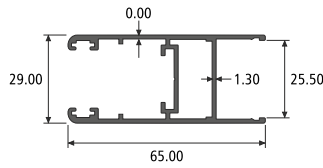

DGU SHUTTER
SECTION NO. : 914897
Weight / Mtr : 0.796

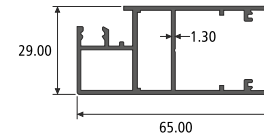

MOSQUITO SHUTTER
SECTION NO. : 992222
Weight / Mtr : 0.816

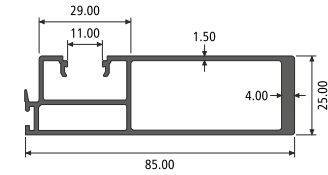

SLEEK REINFORCEMENT INTERLOCK
SECTION NO. : 812858
Weight / Mtr : 1.184

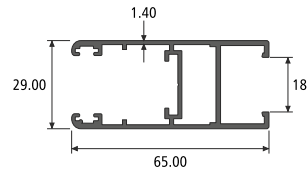

SHUTTER FOR LAMINATED GLASS
SECTION NO. : 992111
Weight / Mtr : 0.890

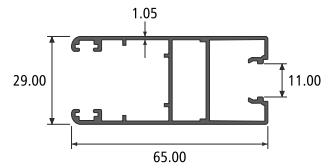

MOSQUITO SHUTTER LIGHT
SECTION NO. : 914900
Weight / Mtr : 0.705

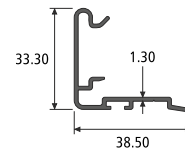

INTERLOCK
SECTION NO. : 914404
Weight / Mtr : 0.350

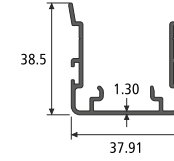

DOUBLE INTERLOCK
SECTION NO. : 817086
Weight / Mtr : 0.528

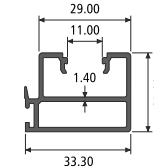

SLEEK INTERLOCK
SECTION NO. : 992324
Weight / Mtr : 0.524

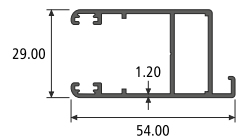

MOSQUITO SHUTTER
SECTION NO. : 914698
Weight / Mtr : 0.617

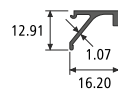

MOSQUITO CLIP
SECTION NO. : 992134
Weight / Mtr : 0.117

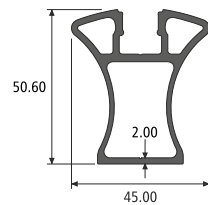

REINFORCEMENT PROFILE
SECTION NO. : 914806
Weight / Mtr : 1.104

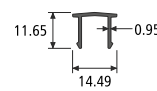

REINFORCEMENT CAP
SECTION NO. : 914565
Weight / Mtr : 0.093

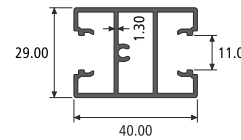

MIDDLE
SECTION NO. : 817032
Weight / Mtr : 0.672

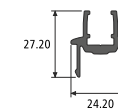

MATING
SECTION NO. : 914530
Weight / Mtr : 0.415

29mm THREE TRACK THREE SHUTTER ASSEMBLY

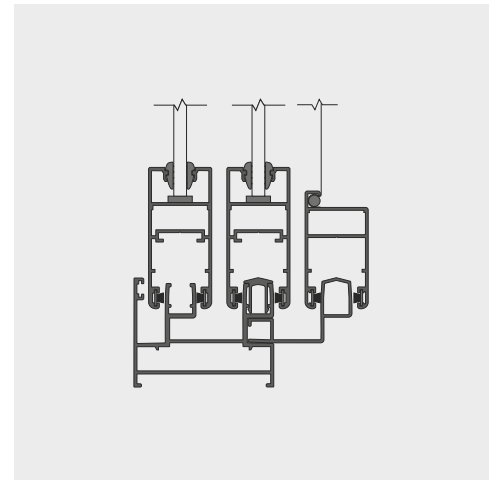
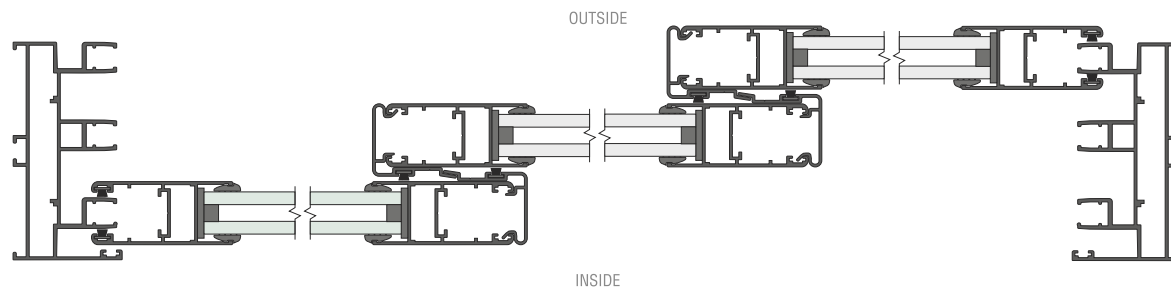
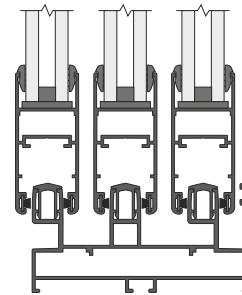
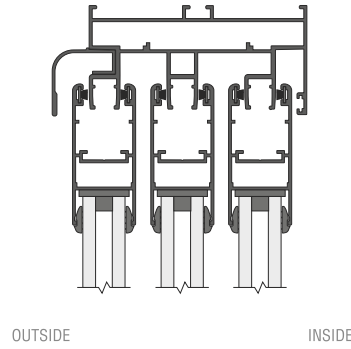
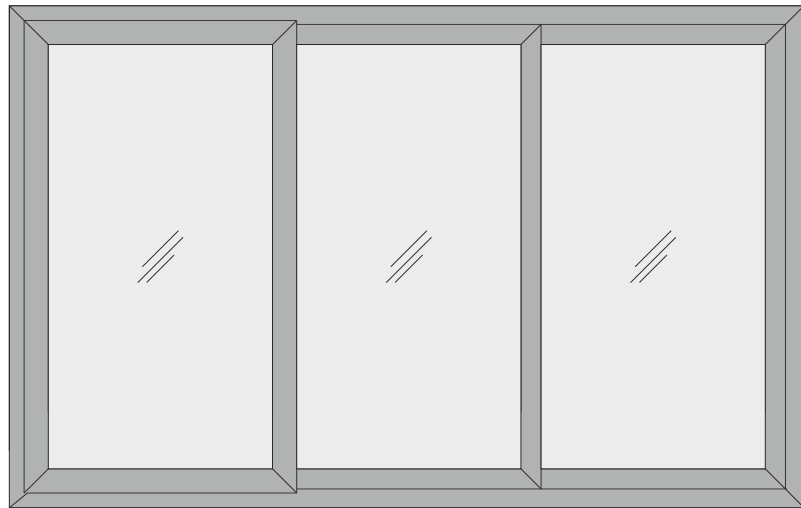

29mm FLYMESH

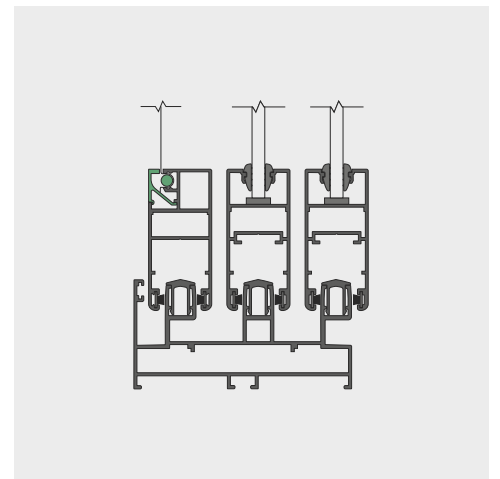

29mm THREE TRACK WITH MOSQUITO

29mm SLEEK TWO TRACK TWO SHUTTER ASSEMBLY

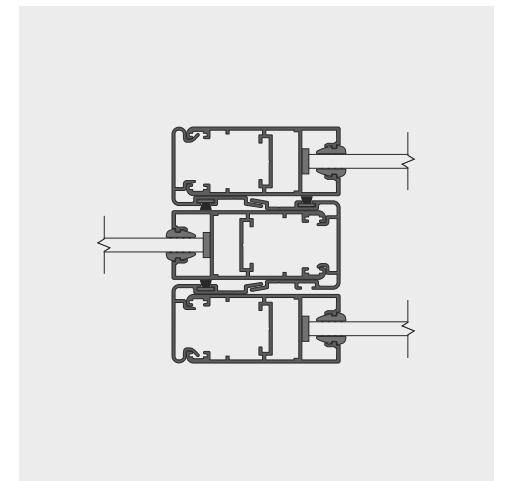
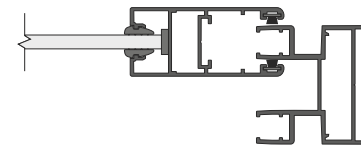
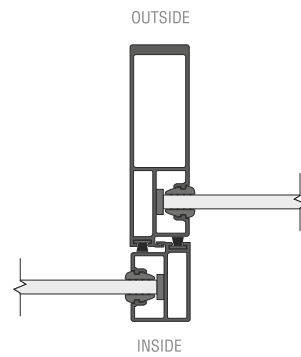
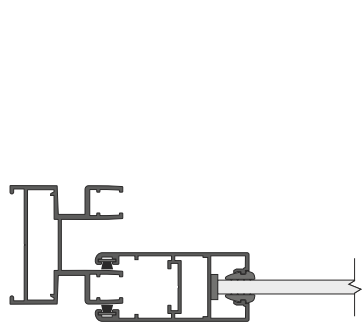
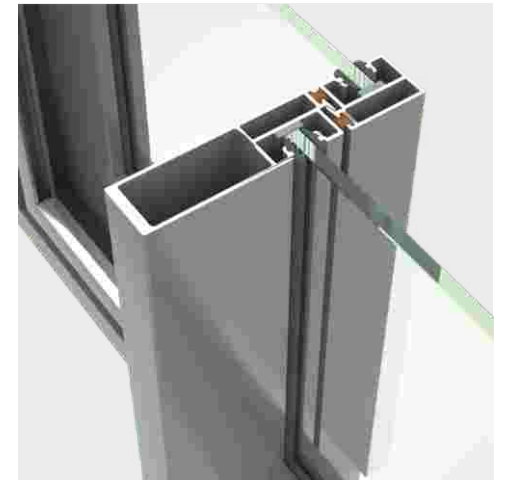
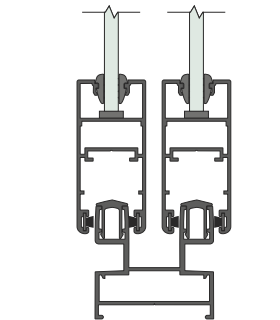
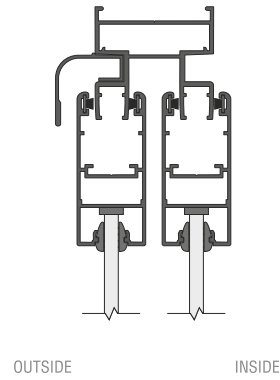

29mm FLYMESH

29mm TWO TRACK FOUR SHUTTER ASSEMBLY

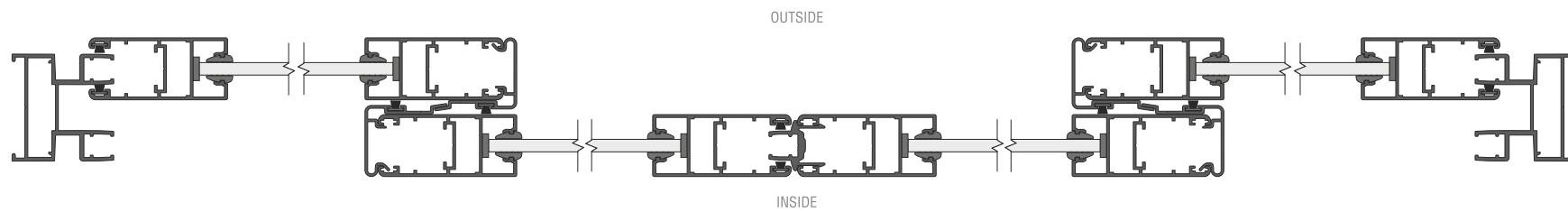
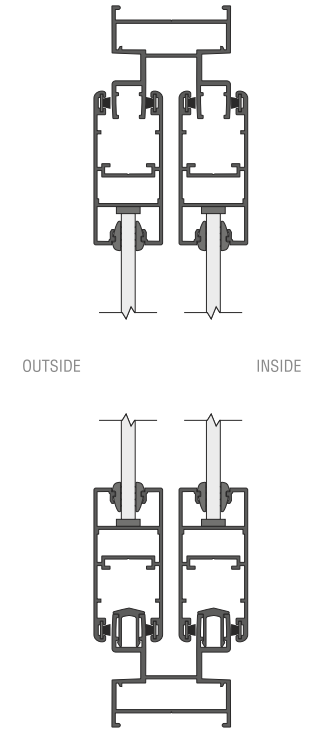
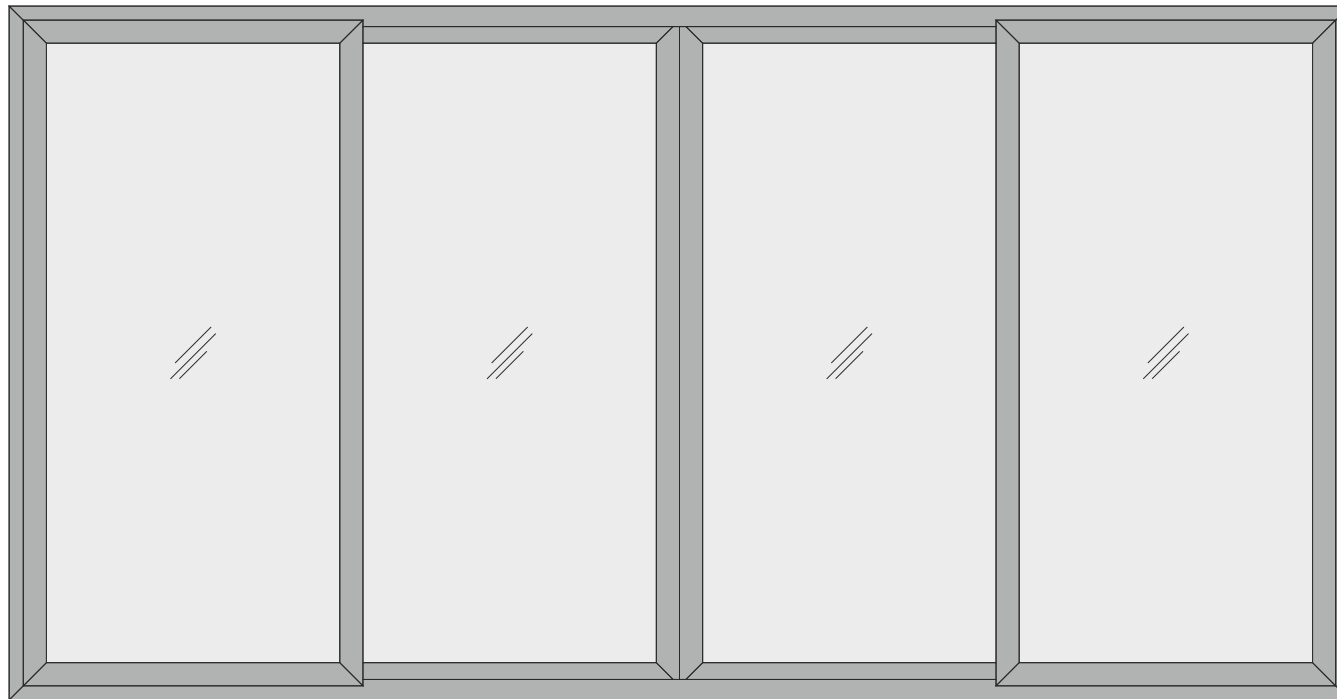

SPACEWIN®
Elegancy at its extreme!



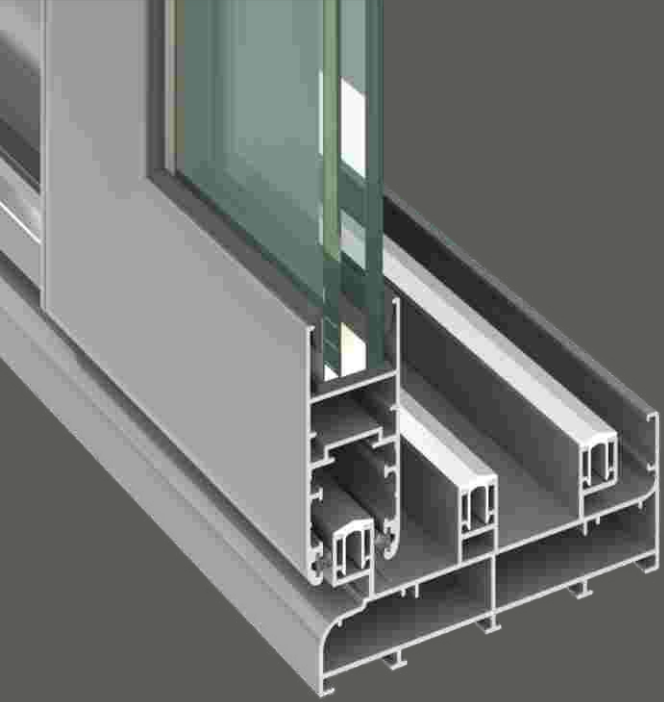

37mm / 37mm SLEEK
SLIDING WINDOWS

FEATURES

Shutter Depth	: 37mm
Locking Type	: Single&Multipoint Lock with Handle
Corner Details	: 45 degree cut with corner connector
Sealing Overlap	: 9 mm (Sealing with wool pile)
Glass Range	: 6 mm To 24 mm
Sightline with Shutter	: 124 mm
2 Track Depth	: 61 mm
3 Track Depth	: 110 mm
Window Height (Max.)	: 3010 mm
Finishes	: Powder/Wood/Anodizing
Hardware & WoolPile	: SCHLEGEL GIESSE

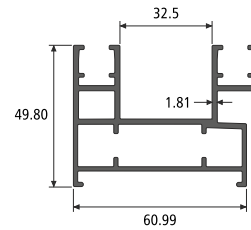

2 TRACK
SECTION NO. : 992248
Weight / Mtr : 1.431

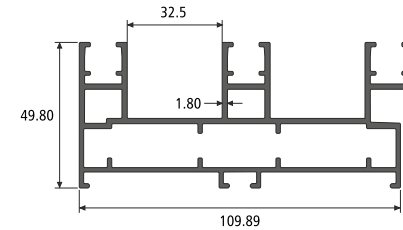

3 TRACK
SECTION NO. : 812514
Weight / Mtr : 2.309

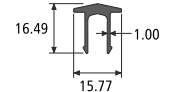

RAIL TRACK
SECTION NO. : 914742
Weight / Mtr : 0.175

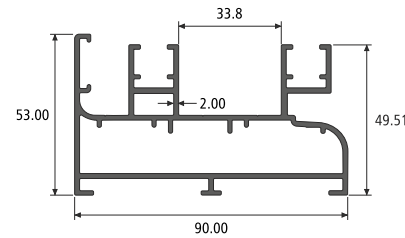

2 TRACK WITH LEG
SECTION NO. : 551015
Weight / Mtr : 1.822

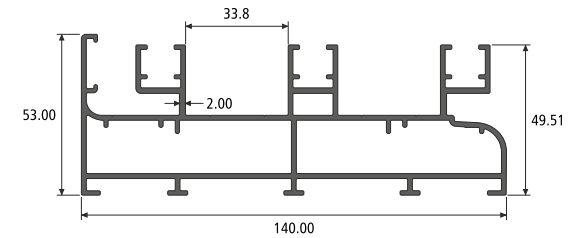

3 TRACK WITH LEG
SECTION NO. : 551016
Weight / Mtr : 2.688

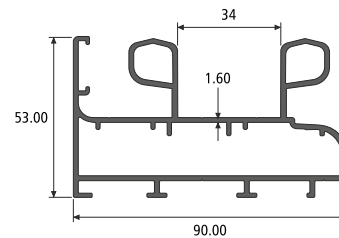

2 TRACK WITH LEG
SECTION NO. : 955077
Weight / Mtr : 1.819

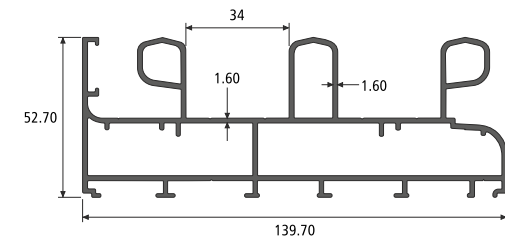

3 TRACK WITH LEG
SECTION NO. : 967067
Weight / Mtr : 2.675

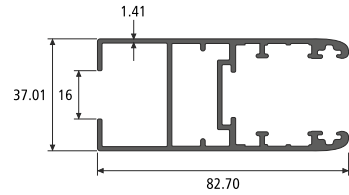

SGU SHUTTER
SECTION NO. : 914668
Weight / Mtr : 1.335

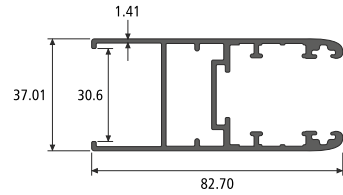

DGU SHUTTER
SECTION NO. : 914409
Weight / Mtr : 1.274

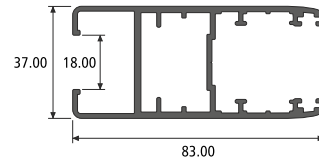

LAMINATED GLASS SHUTTER
SECTION NO. : 992173
Weight / Mtr : 1.450

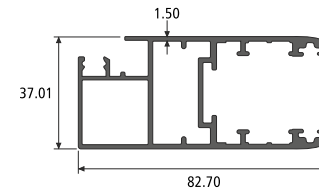

MOSQUITO SHUTTER
SECTION NO. : 992086
Weight / Mtr : 1.397

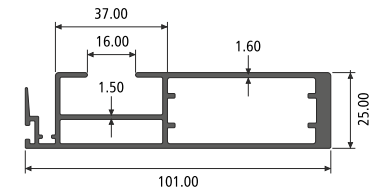

SLEEK REINFORCEMENT INTERLOCK
SECTION NO. : 812859
Weight / Mtr : 1.472

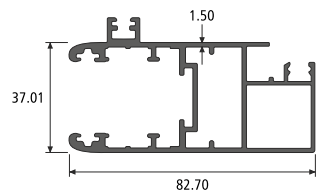

MOSQUITO SHUTTER WITH WOOLPILE SEALING GROOVE
SECTION NO. : 812676
Weight / Mtr : 1.518

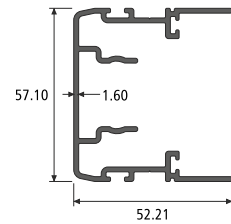

DOUBLE INTERLOCK
SECTION NO. : 817088
Weight / Mtr : 1.055

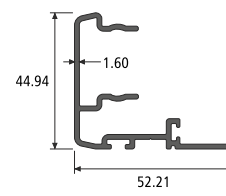

INTERLOCK
SECTION NO. : 955110
Weight / Mtr : 0.689

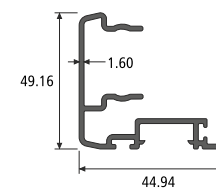

INTERLOCK
SECTION NO. : 992312
Weight / Mtr : 0.693

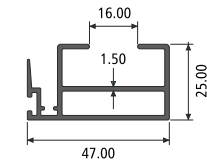

SLEEK INTERLOCK
SECTION NO. : 992326
Weight / Mtr : 0.676

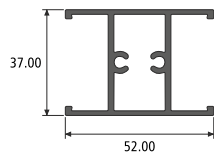

INTERMEDIATE SHUTTER
SECTION NO. : 992091
Weight / Mtr : 0.957

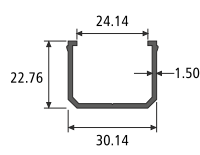

LAMINATED GLASS ADAPTOR
SECTION NO. : 992087
Weight / Mtr : 0.297

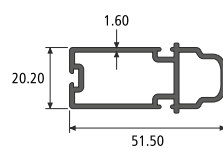

MATING PROFILE FRONT FITTED COUNTER PLATE
SECTION NO. : 817072
Weight / Mtr : 0.720

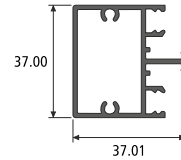

MOSQUITO MIDDLE
SECTION NO. : 817089
Weight / Mtr : 0.673

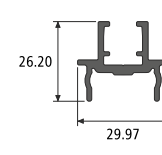

MATING PROFILE INSERTED COUNTER PLATE
SECTION NO. : 992148
Weight / Mtr : 0.478

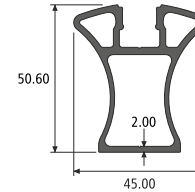

REINFORCEMENT PROFILE
SECTION NO. : 914806
Weight / Mtr : 1.104

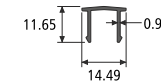

REINFORCEMENT CAP
SECTION NO. : 914565
Weight / Mtr : 0.093

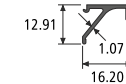

MOSQUITO CLIP
SECTION NO. : 992134
Weight / Mtr : 0.117

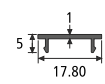

INTERLOCK CAP
SECTION NO. : 992245
Weight / Mtr : 0.071

37mm THREE TRACK THREE SHUTTER ASSEMBLY

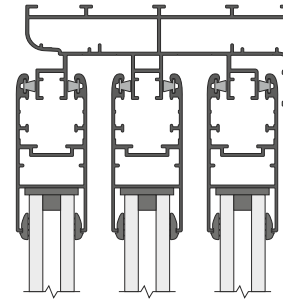
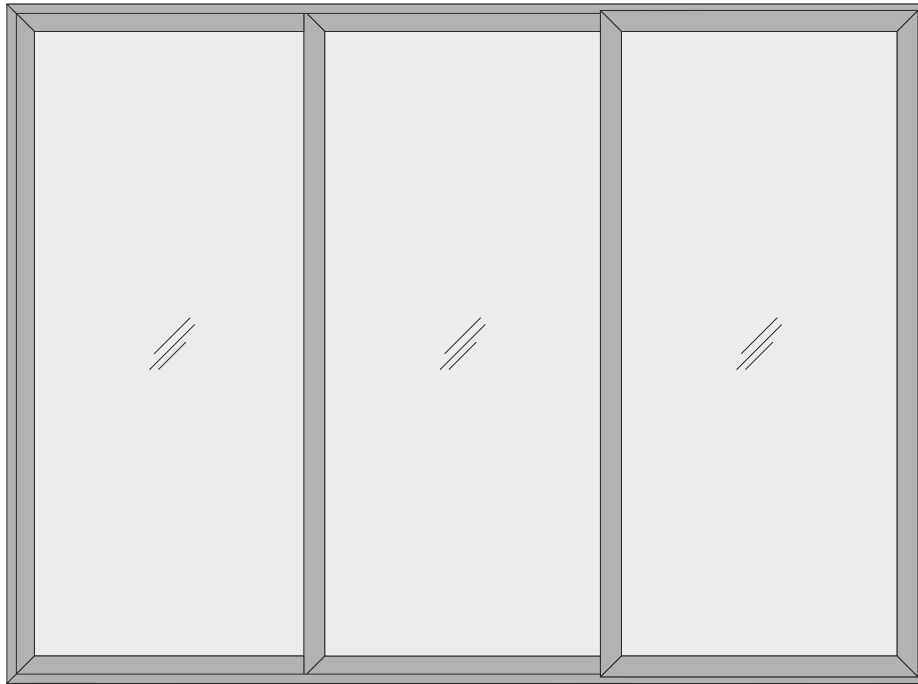

OUTSIDE

INSIDE

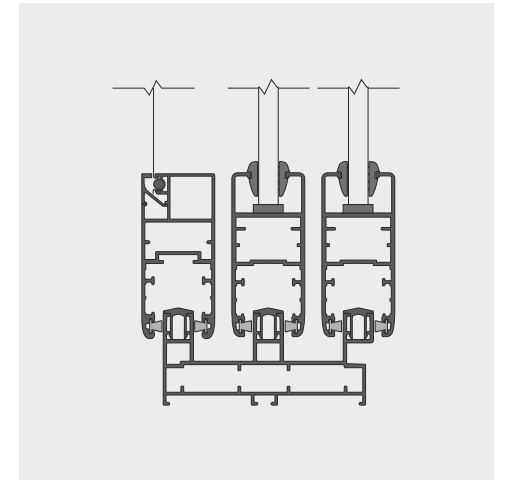
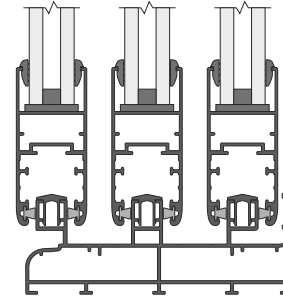

37mm FLYMESH

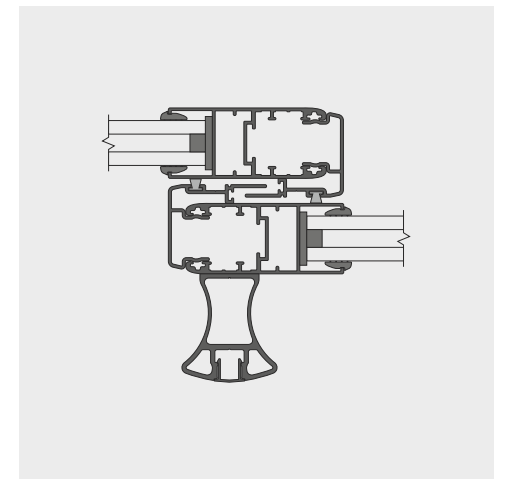

37mm SHUTTER WITH REINFORCEMENT

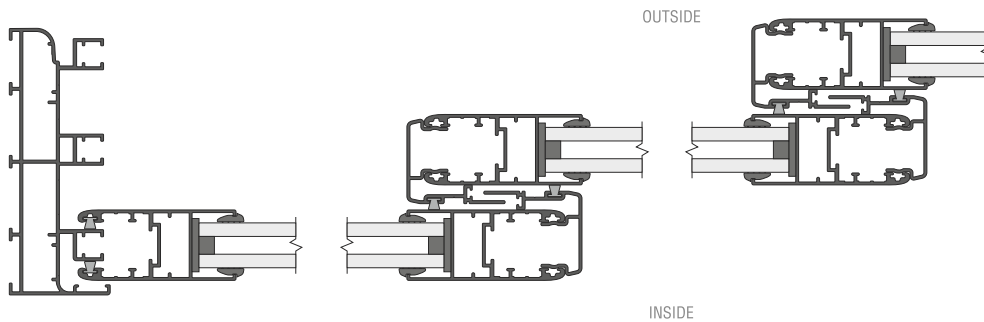

37mm SLEEK TWO TRACK TWO SHUTTER ASSEMBLY

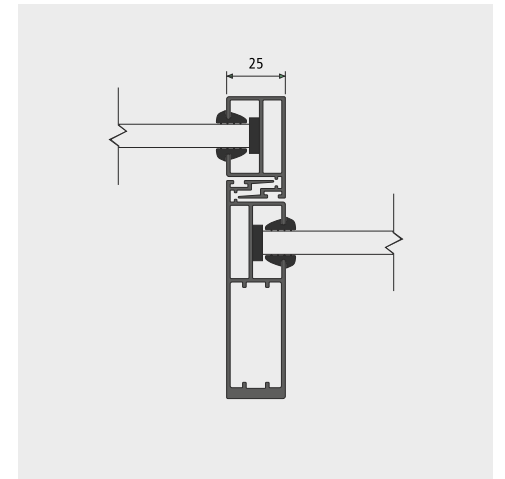
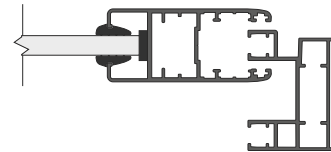
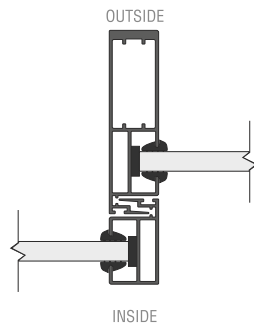
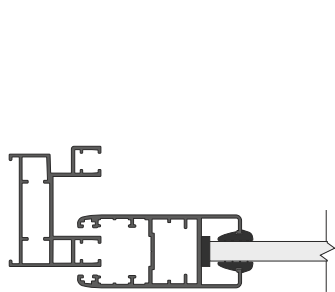
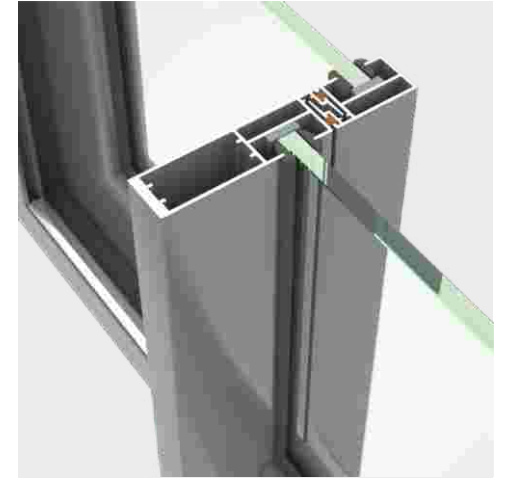
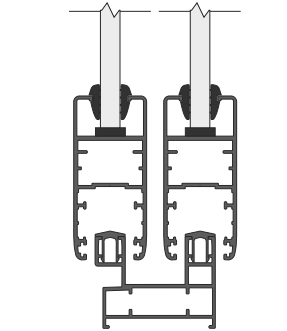
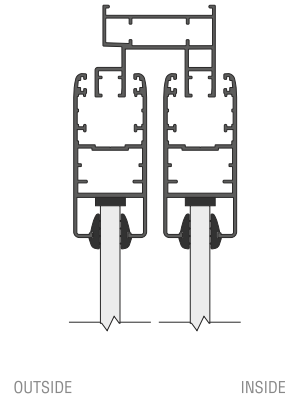
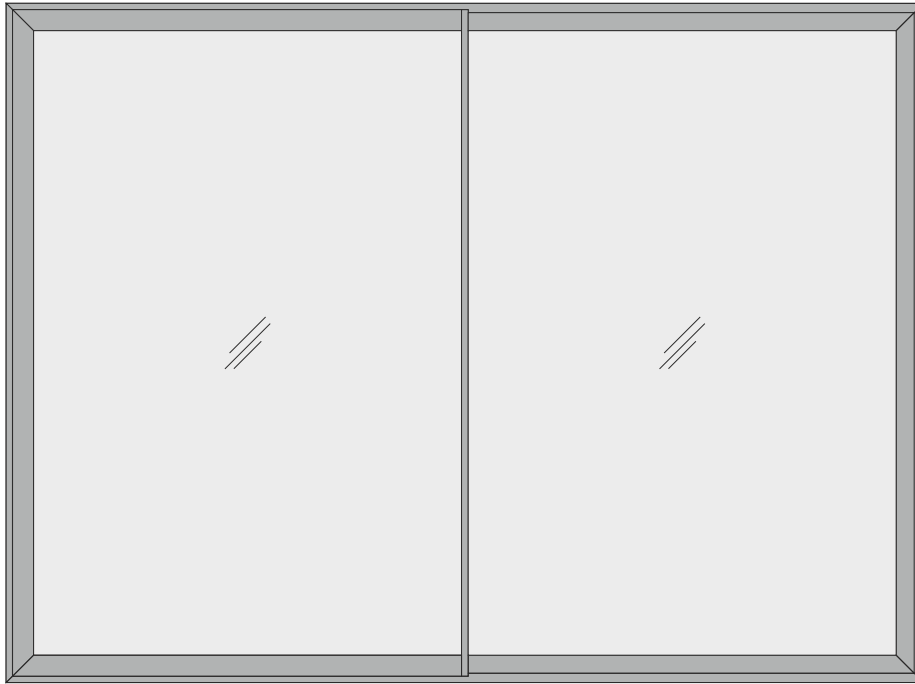

37mm SLEEK INTERLOCK

SPACEWIN®
Elegancy at its extreme!!

CASEMENT WINDOWS

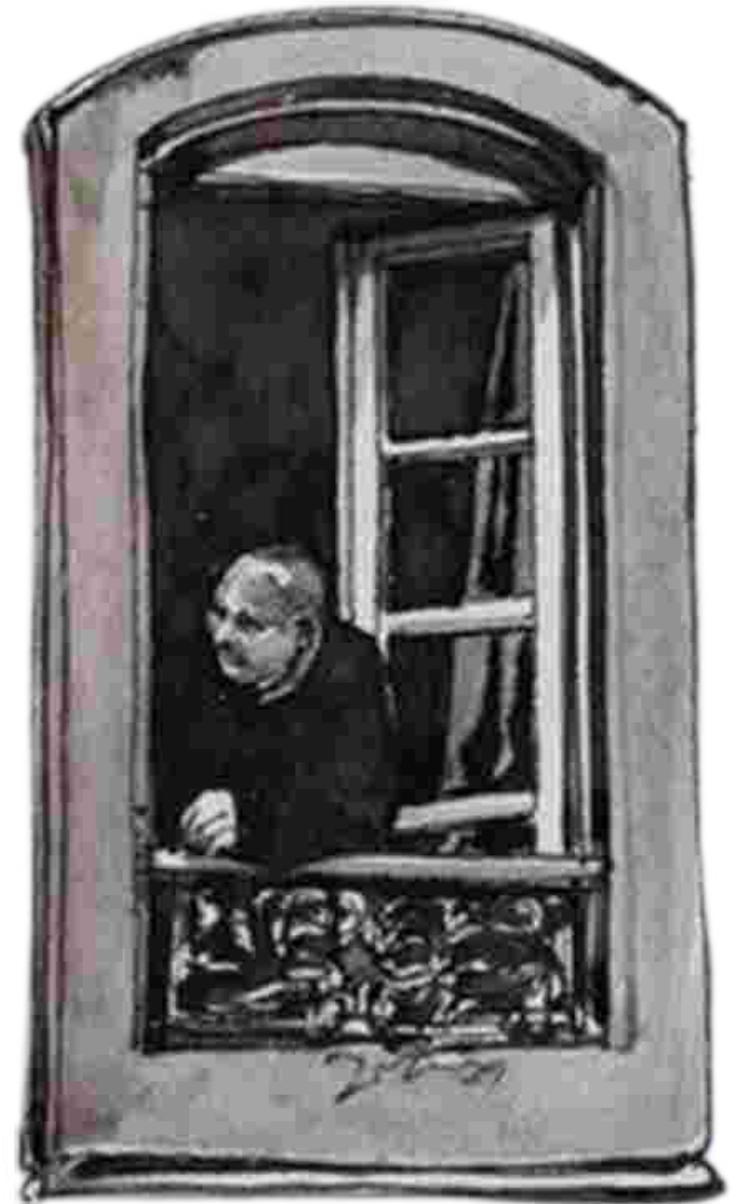

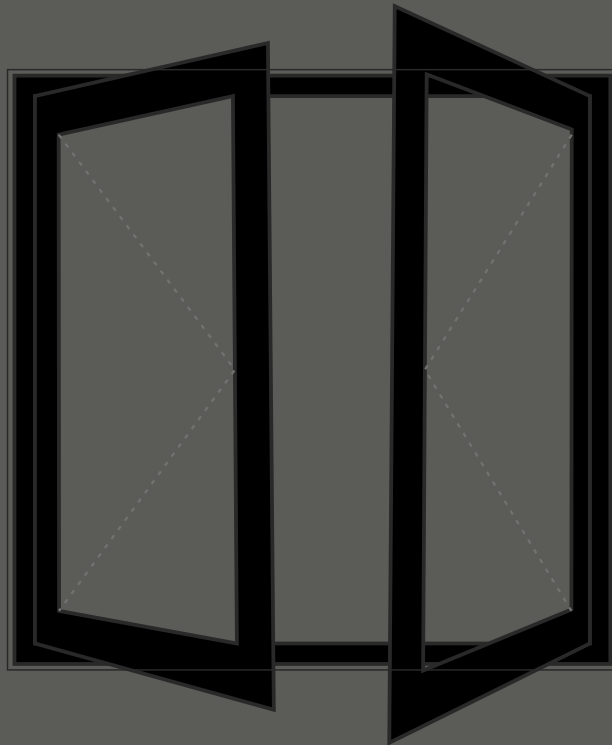

CASEMENT WINDOWS

For those who prefer casement solutions for their windows we present the Ventarch Casement Series. Designed with tropical conditions in mind, we give a full range of options for top hung, side hung with indoor and outdoor opening. Excellent sealing options and flexibility with Euro Groove compatible hardware give fabricators a range of options. Various opening angles with Friction stays and both visible and invisible hinge options satisfy both utilitarian and aesthetic needs. Needless to say, that these are both sound and thermal transfer resistant windows and doors.

30mm | 32mm | 40mm | 50mm

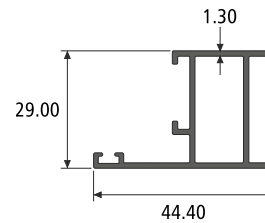
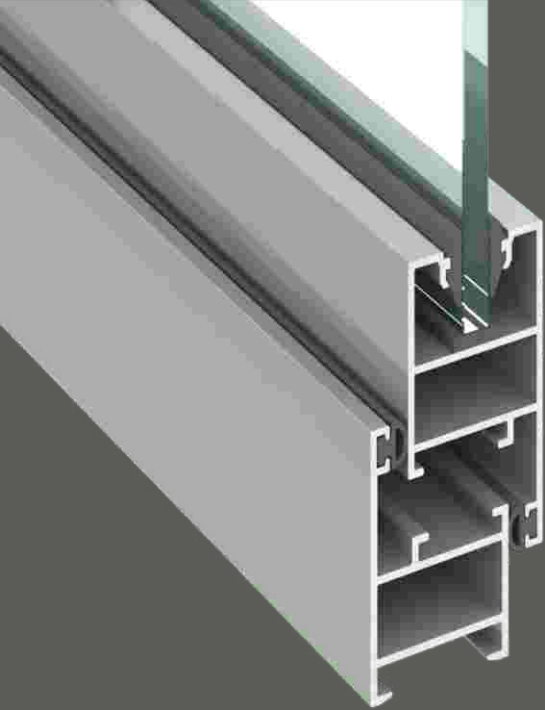

FRAME
SECTION NO. : 992108
Weight / Mtr : 0.497

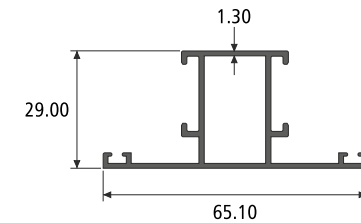

MULLION
SECTION NO. : 992058
Weight / Mtr : 0.584

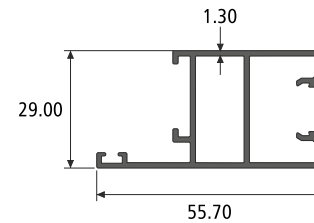

SHUTTER
SECTION NO. : 992110
Weight / Mtr : 0.648

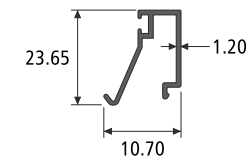

CLIP
SECTION NO. : 992057
Weight / Mtr : 0.200

30mm
CASEMENT WINDOWS

FEATURES

Frame Depth	: 30mm
Locking Type	: Single&Multipoint Lock with Handle
Glass Range	: 4 mm to 6mm
Openable Sight Line	: 73.4 mm
Fix Sight Line	: 44.4 mm
Corner Details	: 45 degree cut with corner connector
Sealing Overlap	: 6 mm (Sealing with Gasket)
Window Height (Max.)	: 1530 mm
Hardware	: SCHLEGEL GIESSE

30mm FIX WINDOW

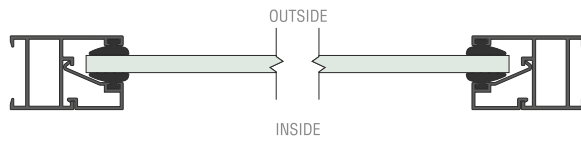
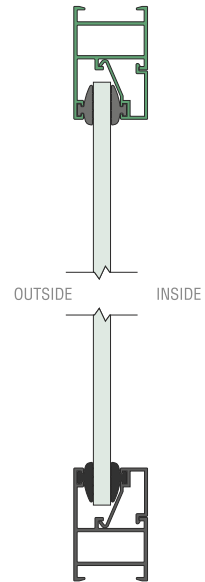
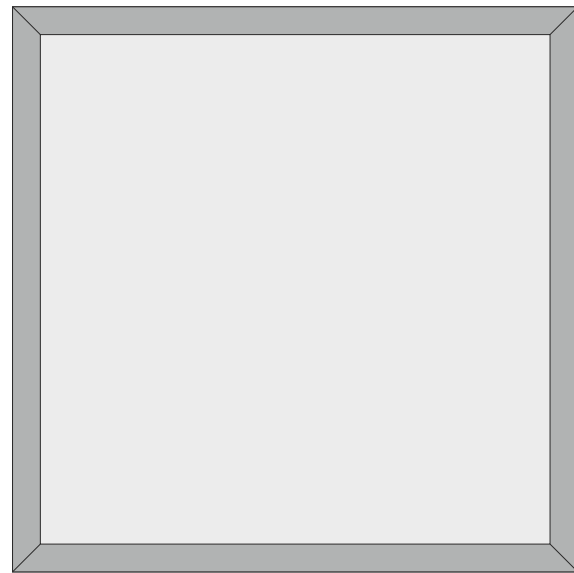

30mm TOP HUNG WINDOW

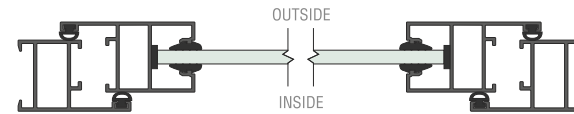
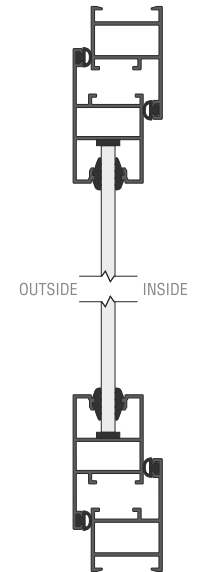
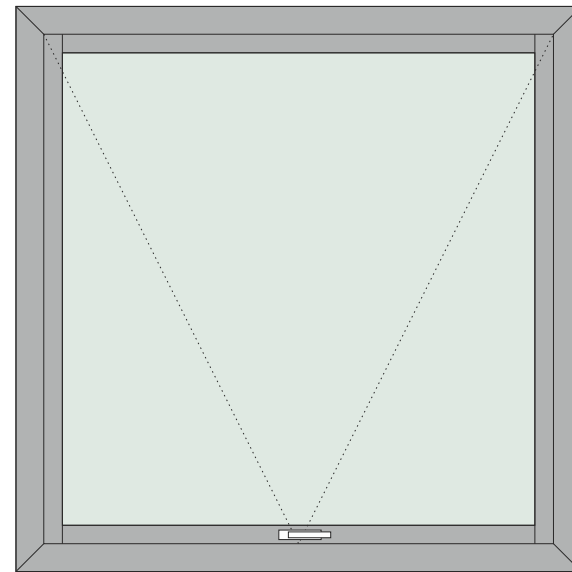

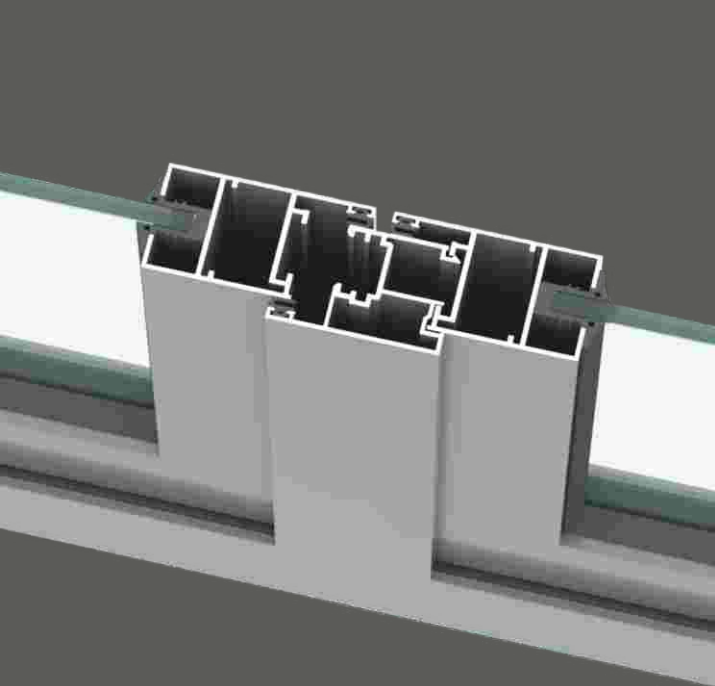

32mm
CASEMENT WINDOWS

FEATURES

Frame Depth	: 32 mm
Locking Type	: Single & Multipoint Lock with Handle
Glass Range	: 4 mm to 6mm
Openable Sight Line	: 76.4 mm
Fix Sight Line	: 40 mm
Corner Details	: 45 degree cut with corner connector
Sealing Overlap	: 6mm (Sealing with Gasket)
Window Height (Max.)	: 1650 mm
Hardware	: SCHLEGEL GIESSE

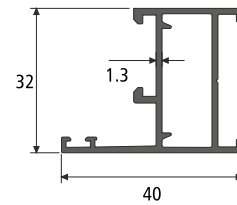

FRAME
SECTION NO. : 745611
Weight / Mtr : 0.449

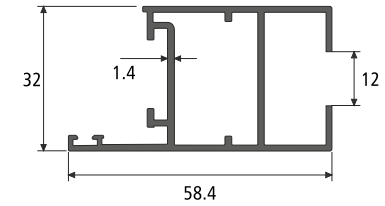

IN / OUT OPENABLE SHUTTER
SECTION NO. : 819080
Weight / Mtr : 0.726

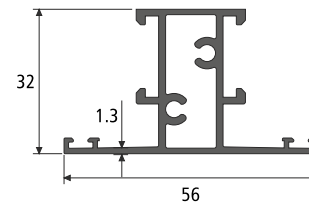

MULLION
SECTION NO. : 819081
Weight / Mtr : 0.694

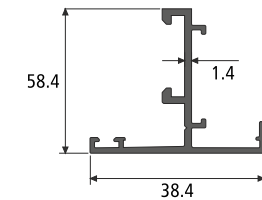

INVERSION PROFILE
SECTION NO. : 746510
Weight / Mtr : 0.369

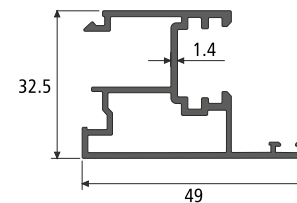

FLYING MULLION
SECTION NO. : 819082
Weight / Mtr : 0.623

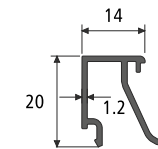

SGU CLIP
SECTION NO. : 746509
Weight / Mtr : 0.202

32mm FIX + OUTWARD OPENABLE WINDOW

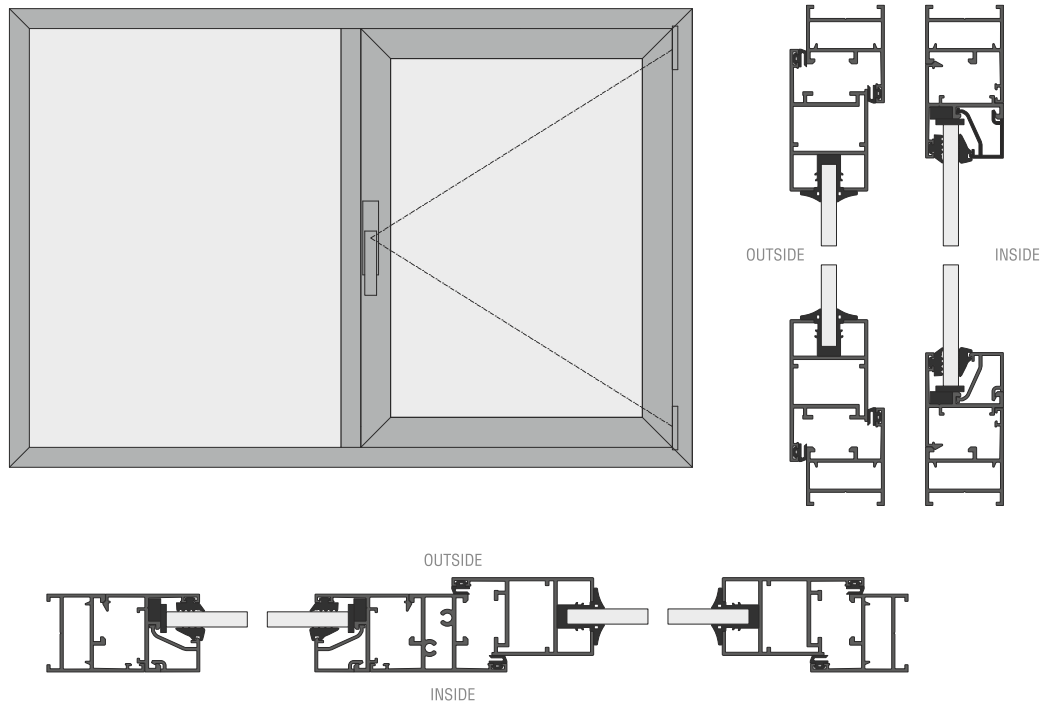

32mm DOUBLE WINDOW INWARD OPENABLE

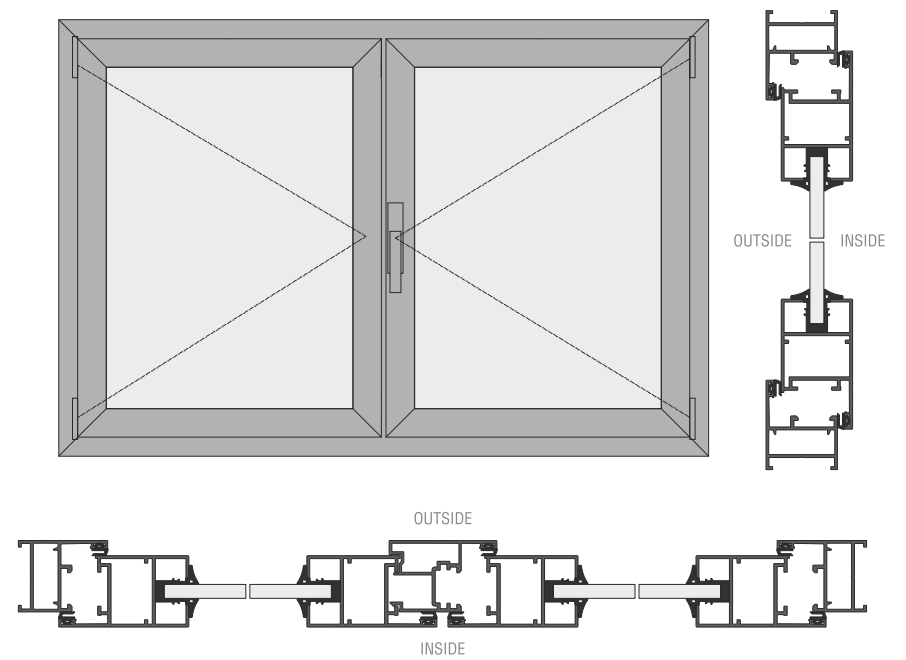

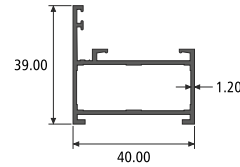
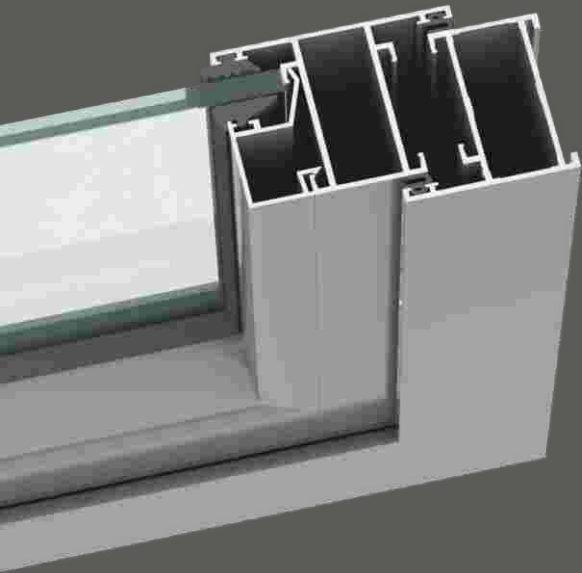

FRAME
SECTION NO. : 914028
Weight / Mtr : 0.547

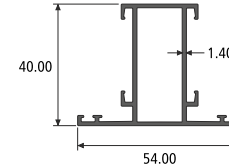

INSIDE / OUTSIDE SHUTTER
SECTION NO. : 914890
Weight / Mtr : 0.660

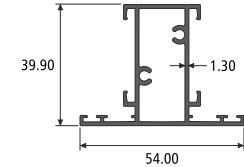

MULLION
SECTION NO. : 819006
Weight / Mtr : 0.715

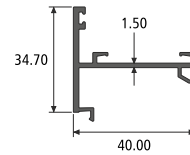

INVERSION
SECTION NO. : 819014
Weight / Mtr : 0.433

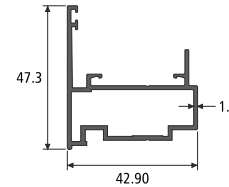

FLING MULLION
SECTION NO. : 819002
Weight / Mtr : 0.662

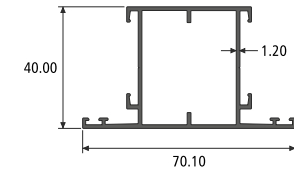

BIG SHUTTER
SECTION NO. : 914891
Weight / Mtr : 0.755

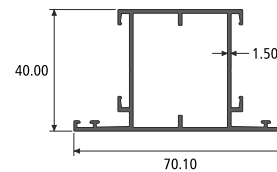

BIG SHUTTER
SECTION NO. : 819013
Weight / Mtr : 0.867

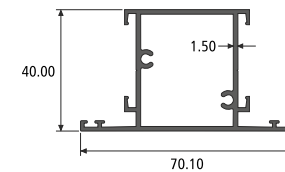

MULLION
SECTION NO. : 819008
Weight / Mtr : 0.905

40mm
CASEMENT WINDOWS

FEATURES

Frame Depth	: 40mm
Locking Type	: Single&Multipoint Lock with Handle
Glass Range	: 5 mm to 28 mm
Openable Sight Line	: 72.3 mm
Fix Sight Line	: 39 mm
Corner Details	: 45 degree cut with corner connector
Sealing Overlap	: 6mm (Sealing with Gasket)
Window Height (Max.)	: 1830 mm
Hardware	: SCHLEGEL GIESSE

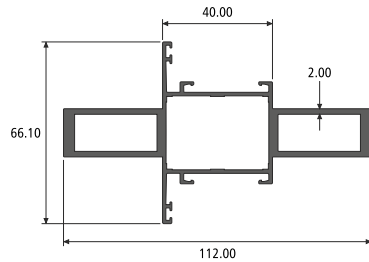

REINFORCEMENT MULLION
SECTION NO. : 819012
Weight / Mtr : 1.961

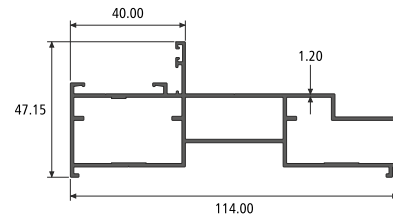

FRAME
SECTION NO. : 817023
Weight / Mtr : 1.252

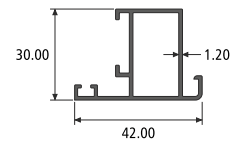

MOSQUITO SHUTTER
SECTION NO. : 914517
Weight / Mtr : 0.468

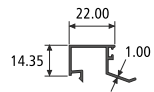

SGU CLIP (upto 8mm Glass)
SECTION NO. : 914030
Weight / Mtr : 0.210

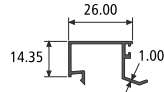

SGU CLIP (upto 5mm Glass)
SECTION NO. : 817091
Weight / Mtr : 0.213

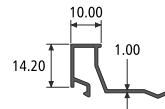

DGU CLIP (upto 21mm Glass)
SECTION NO. : 817050
Weight / Mtr : 0.187

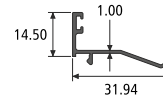

DGU CLIP (upto 26mm Glass)
SECTION NO. : 817921
Weight / Mtr : 0.159

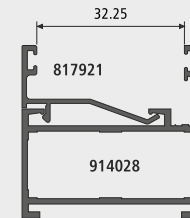
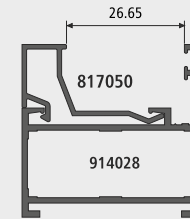
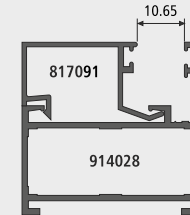
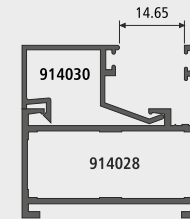

VARIOUS CLIP DETAILS

40mm CASEMENT WINDOWS (OUTSIDE DOUBLE OPENABLE WITH FLYING MULLION)

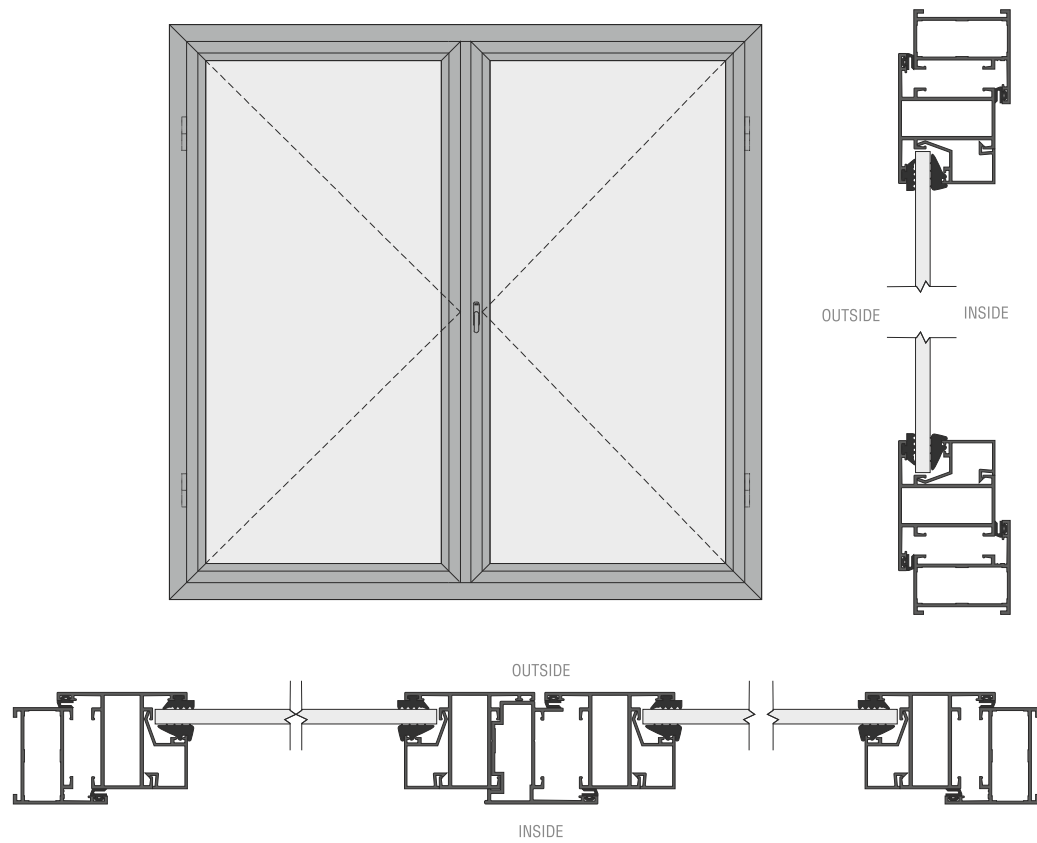

40mm CASEMENT WINDOWS (OUTSIDE OPENABLE)

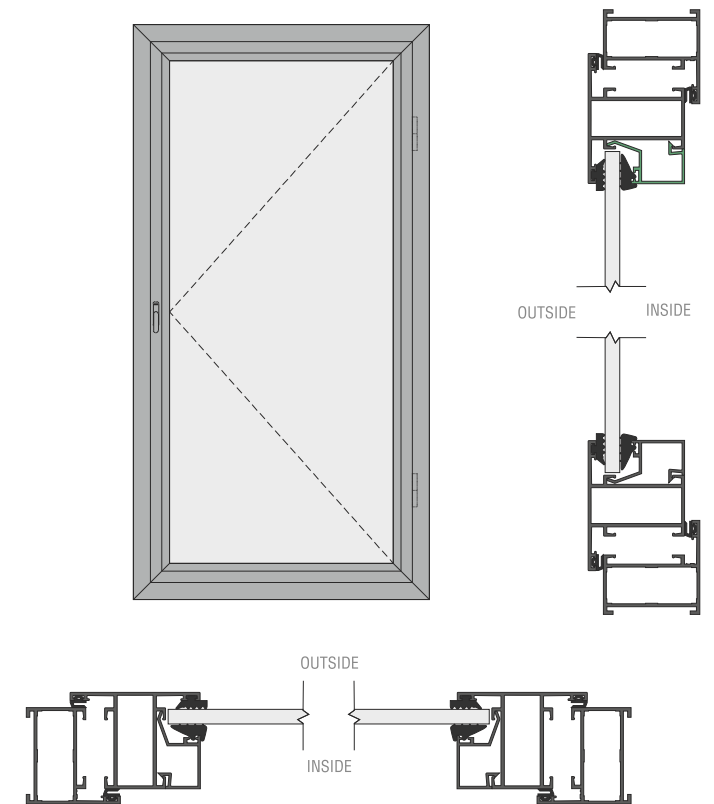

SPACEWIN®
Elegancy at its extreme!!



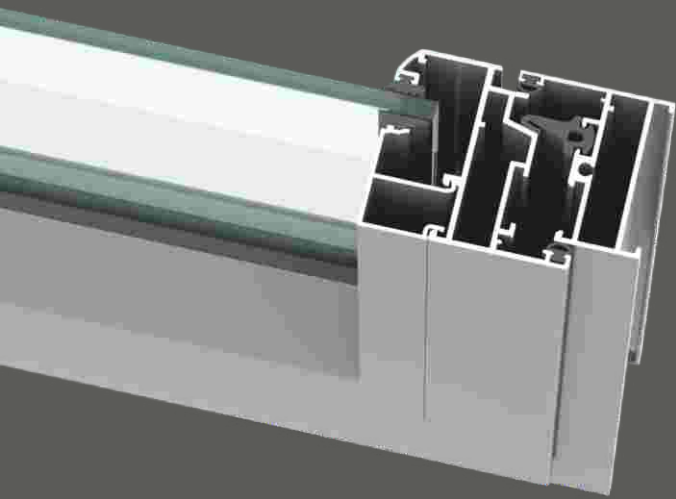

50mm
CASEMENT WINDOWS

FEATURES

Frame Depth	: 50mm
Locking Type	: Single&Multipoint Lock with Handle
Glass Range	: 5 mm to 38mm
Openable Sight Line	: 97.5mm
Fix Sight Line	: 46 mm
Corner Details	: 45 degree cut with corner connector
Sealing Overlap	: 6mm (Sealing with Gasket)
Window Height (Max.)	: 2100 mm
Hardware	: SCHLEGEL GIESSE

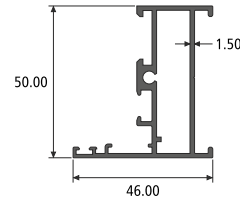

FRAME
SECTION NO. : 914351
Weight / Mtr : 0.818

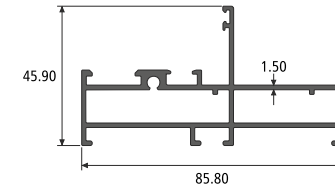

BIG FRAME
SECTION NO. : 914756
Weight / Mtr : 1.185

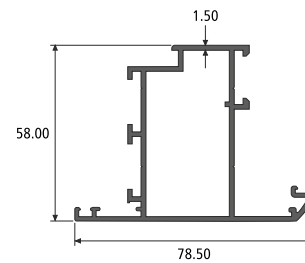

OUTSIDE OP. SHUTTER
SECTION NO. : 914353
Weight / Mtr : 1.138

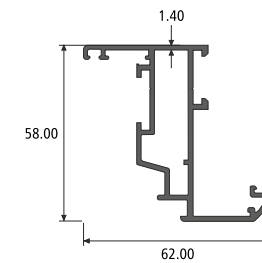

INSIDE OP. SHUTTER
SECTION NO. : 914520
Weight / Mtr : 0.955

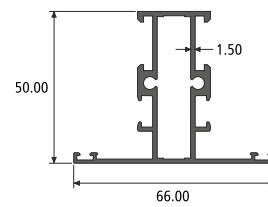

MULLION
SECTION NO. : 914352
Weight / Mtr : 1.015

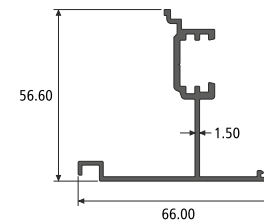

FLYING MULLION
SECTION NO. : 914797
Weight / Mtr : 0.707

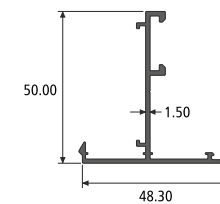

INVERSION
SECTION NO. : 914564
Weight / Mtr : 0.508

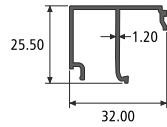

SGU CLIP
SECTION NO. : 914549
Weight / Mtr : 0.305

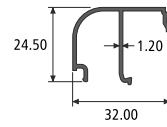

SGU RADIUS CLIP
SECTION NO. : 914354
Weight / Mtr : 0.290

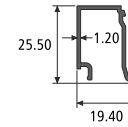

DGU CLIP
SECTION NO. : 914641
Weight / Mtr : 0.230

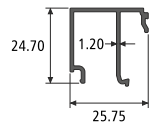

LAMINATED GLASS CLIP
SECTION NO. : 992095
Weight / Mtr : 0.288

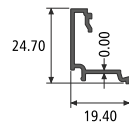

DGU CLIP (upto 33mm Glass)
SECTION NO. : 992036
Weight / Mtr : 0.193

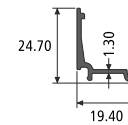

DGU CLIP (upto 38mm Glass)
SECTION NO. : 914868
Weight / Mtr : 0.185

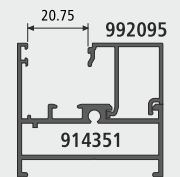
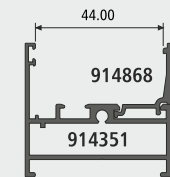
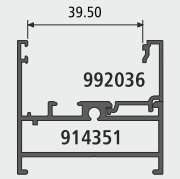
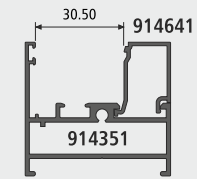
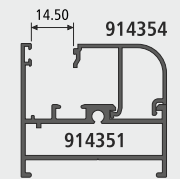
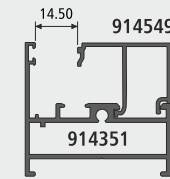

VARIOUS CLIP DETAILS

50mm CASEMENT WINDOW (INSIDE OPENABLE DOUBLE WITH FLYING MULLION)

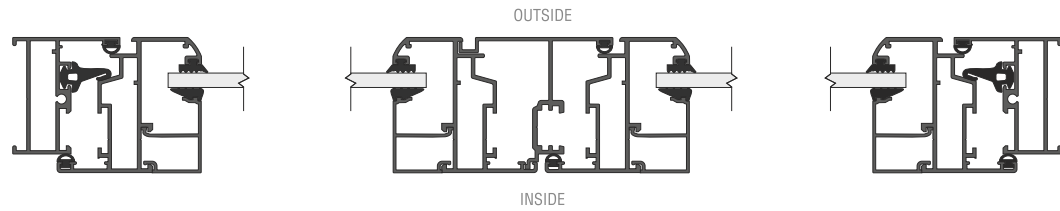
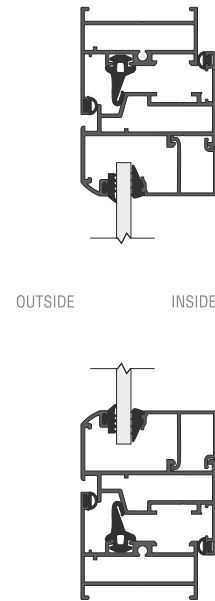
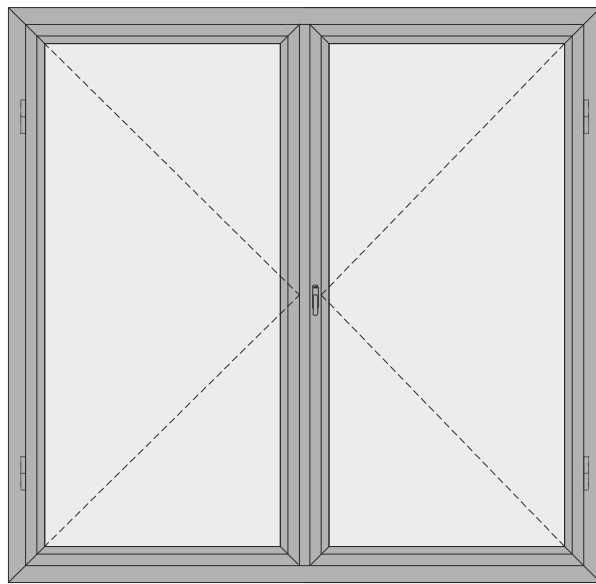

50mm CASEMENT WINDOW (INSIDE OPENABLE)

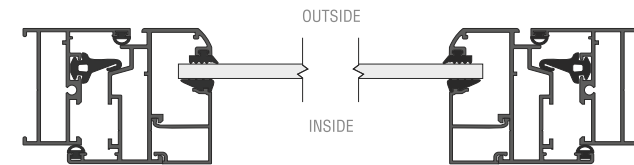
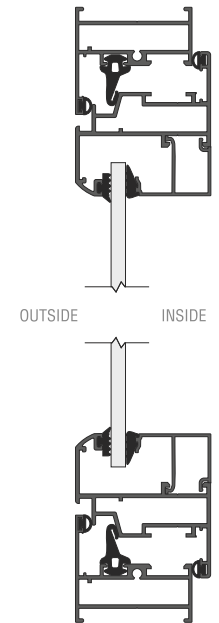
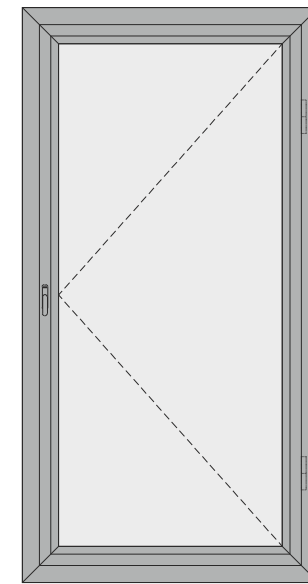

50mm CASEMENT WINDOW (FIX + OUTSIDE OPENABLE)

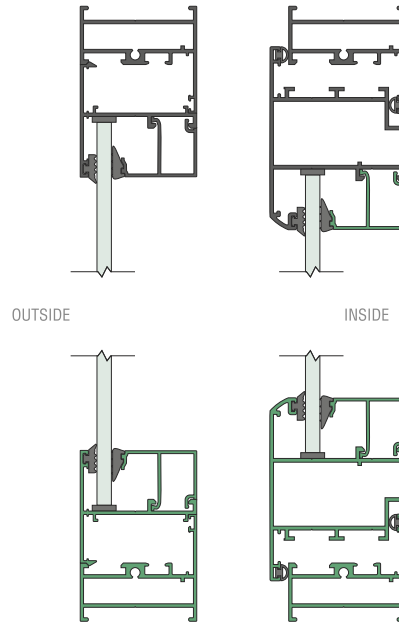
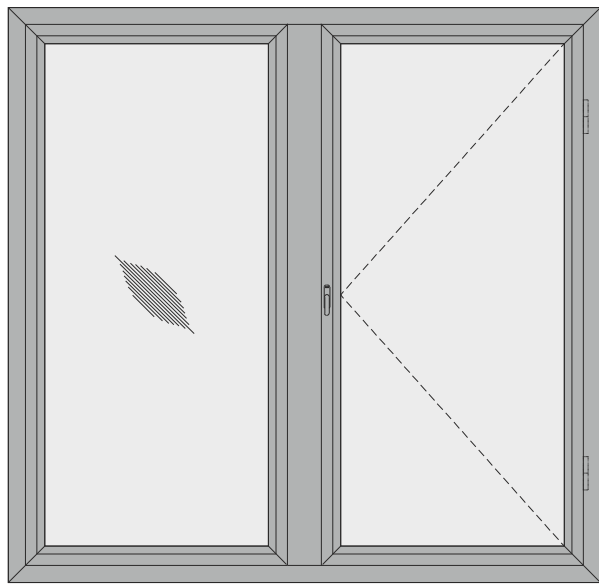

50mm CASEMENT WINDOW (TOP HUNG)

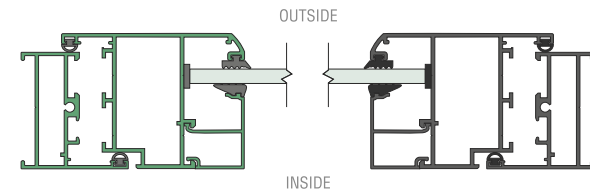
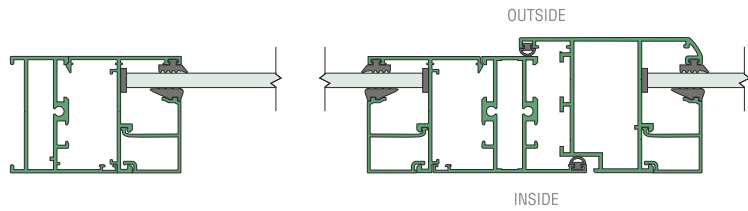
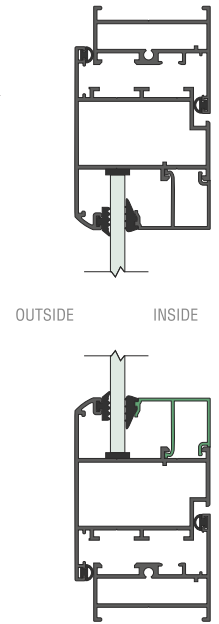
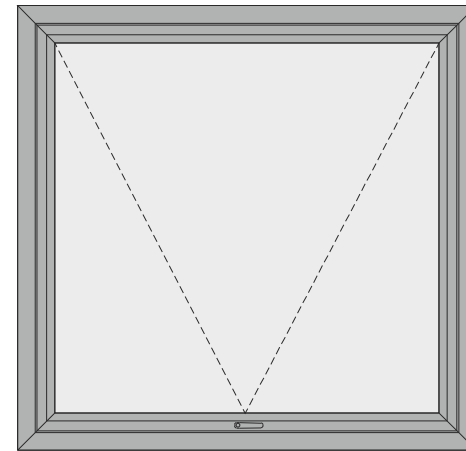

SPACEWIN®
Elegancy at its extreme!!

CASEMENT DOOR



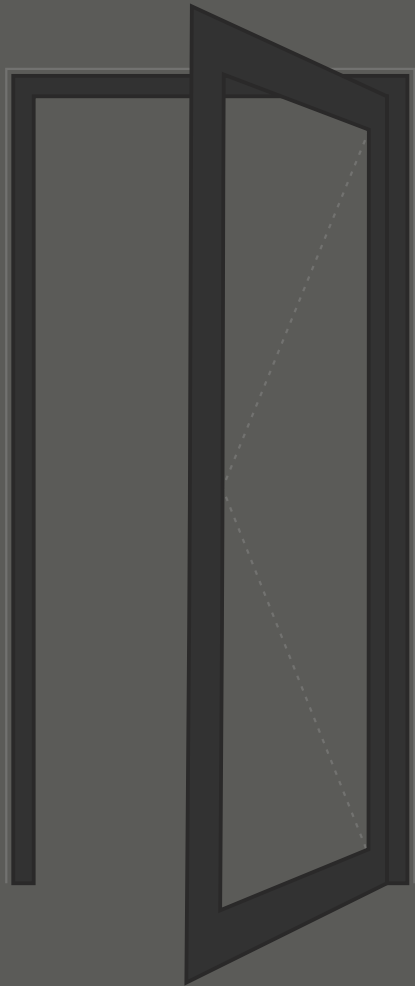

CASEMENT DOORS

Double leaf doors with flying mullion and frameless bottom section with full SGU and DGU compatibility are also available. Excellent Sealing and flexibility with Euro Groove compatible hardware give fabricators a range of options. Availability of both visible and invisible hinges satisfy both utilitarian and aesthetic needs. Needless to say, that these are both sound and thermal transfer resistant windows and doors.

40mm | 50mm

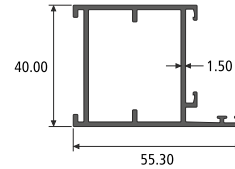

DOOR FRAME
SECTION NO. : 819022
Weight / Mtr : 0.783

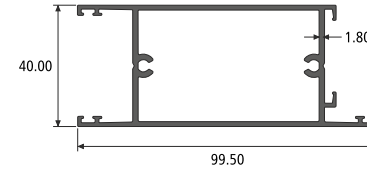

DOOR - BOTTOM
SECTION NO. : 812659
Weight / Mtr : 1.298

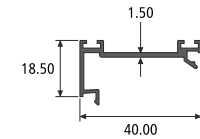

DOOR-BOTTOM-ADAPTOR
SECTION NO. : 817918
Weight / Mtr : 0.305

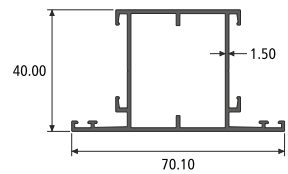

BIG SHUTTER
SECTION NO. : 819013
Weight / Mtr : 0.867

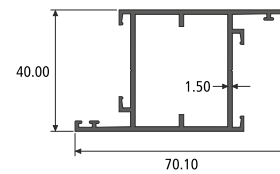

Z MULLION SHUTTER
SECTION NO. : 819021
Weight / Mtr : 0.870

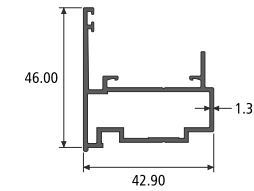

FLYING MULLION
SECTION NO. : 819002
Weight / Mtr : 0.662

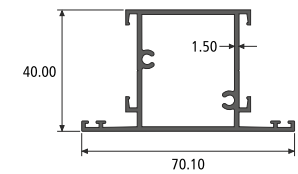

MULLION
SECTION NO. : 819008
Weight / Mtr : 0.905

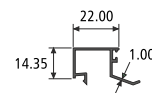

SGU CLIP
SECTION NO. : 914030
Weight / Mtr : 0.210

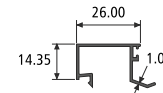

SGU CLIP
SECTION NO. : 817091
Weight / Mtr : 0.213

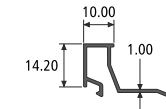

DGU CLIP
SECTION NO. : 817050
Weight / Mtr : 0.187

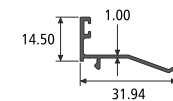

DGU CLIP
SECTION NO. : 817921
Weight / Mtr : 0.159

40mm
CASEMENT DOOR

FEATURES

Frame Depth	: 40mm
Locking Type	: Single&Multipoint Lock with Handle
Glass Range	: 5 mm to 28 mm
Openable Sight Line	: 104.4 mm
Fix Sight Line	: 55.3 mm
Corner Details	: 45 degree cut with corner connector
Sealing Overlap	: 6mm (Sealing with Gasket)
Window Height (Max.)	: 2135 mm
Hardware	: SCHLEGEL GIESSE

40mm CASEMENT DOOR (DGU GLASS INSIDE OPENABLE)

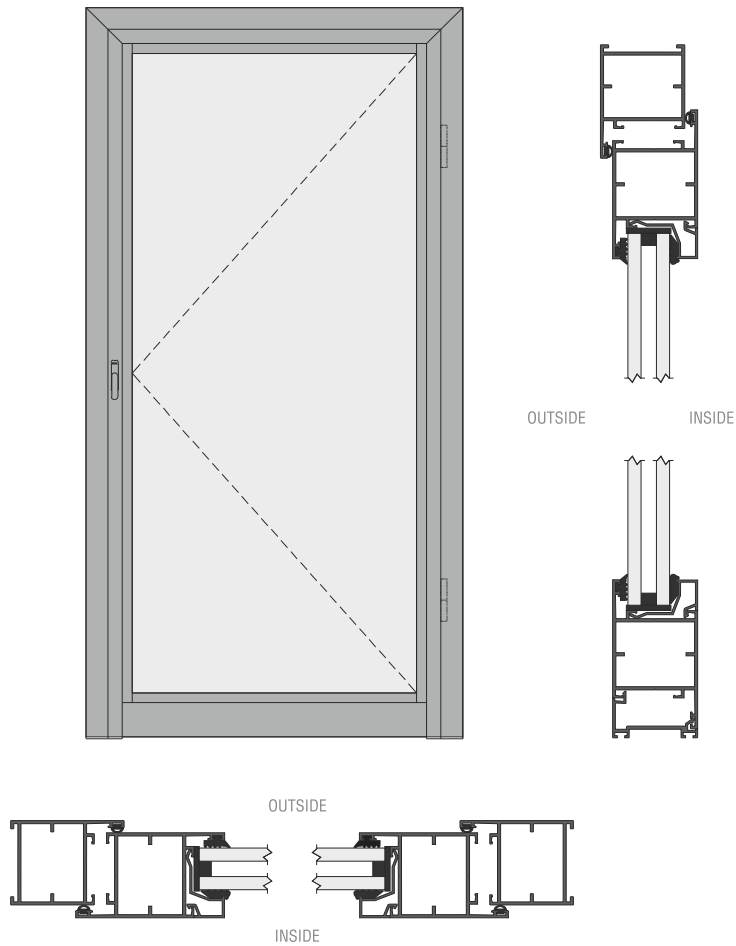

40mm CASEMENT DOOR (SGU GLASS OUTSIDE OPENABLE)

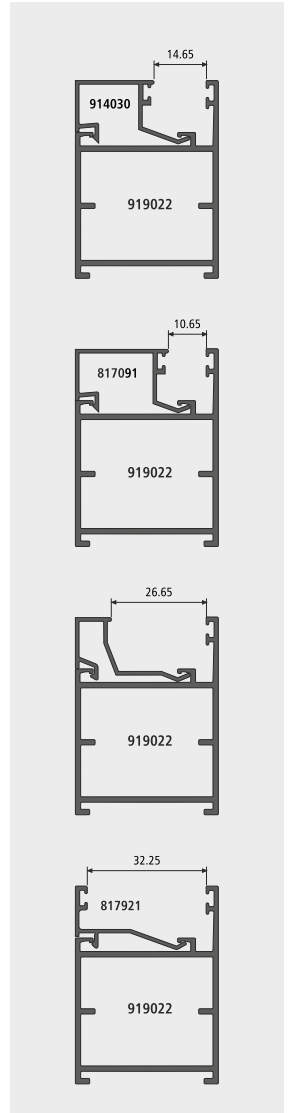
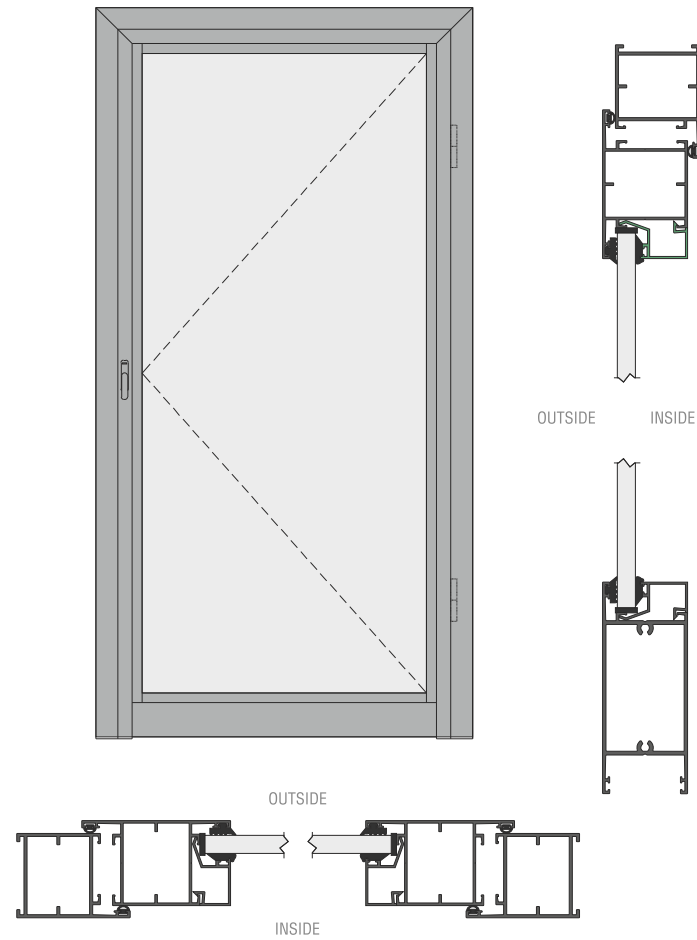

VARIOUS CLIP DETAILS

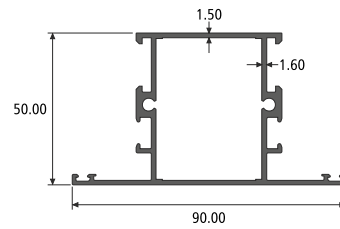

MULLION
SECTION NO. : 914774
Weight / Mtr : 1.235

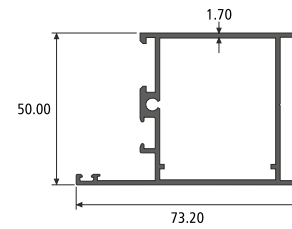

FRAME
SECTION NO. : 914775
Weight / Mtr : 1.080

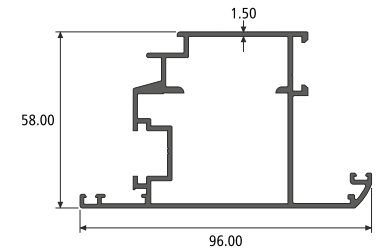

**OUTSIDE OP. SHUTTER
(MULTI POINT LOCKING)**
SECTION NO. : 992214
Weight / Mtr : 1.402

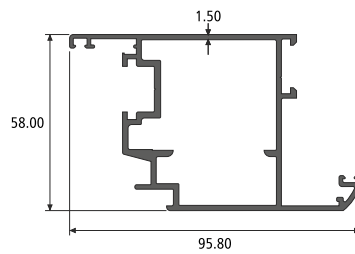

INSIDE OP. SHUTTER
SECTION NO. : 992109
Weight / Mtr : 1.540

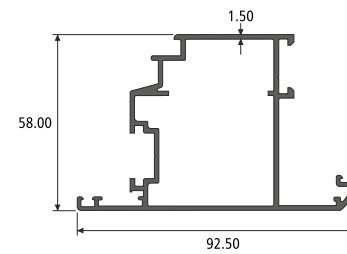

**OUTSIDE OP. SHUTTER
(SINGLE POINT LOCKING)**
SECTION NO. : 914776
Weight / Mtr : 1.292

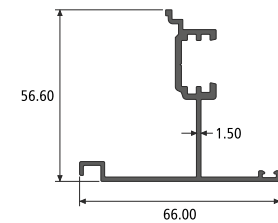

FLYING MULLION
SECTION NO. : 914797
Weight / Mtr : 0.707

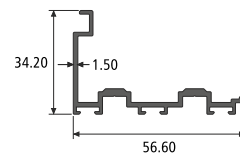

DOOR BOTTOM ADAPTOR
SECTION NO. : 992208
Weight / Mtr : 0.526

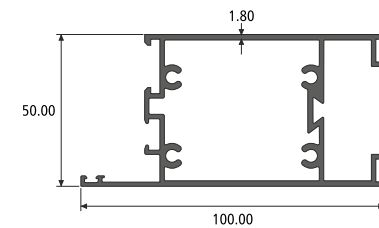

DOOR BOTTOM
SECTION NO. : 914777
Weight / Mtr : 1.766

50mm
CASEMENT DOOR

FEATURES

Frame Depth	: 50mm
Locking Type	: Single&Multipoint Lock with Handle
Glass Range	: 5 mm to 38mm
Openable Sight Line	: 142 mm
Fix Sight Line	: 74 mm
Corner Details	: 45 degree cut with corner connector
Sealing Overlap	: 6mm (Sealing with Gasket)
Window Height (Max.)	: 2440 mm
Hardware	: SCHLEGEL GIESSE

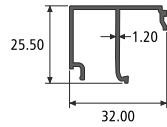

SGU CLIP
SECTION NO. : 914549
Weight / Mtr : 0.305

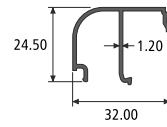

SGU RADIUS CLIP
SECTION NO. : 914354
Weight / Mtr : 0.290

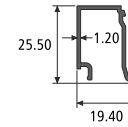

DGU CLIP
SECTION NO. : 914641
Weight / Mtr : 0.228

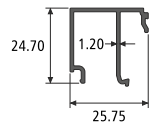

LAMINATED GLASS CLIP
SECTION NO. : 992095
Weight / Mtr : 0.288

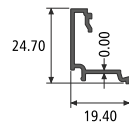

DGU CLIP(upto 33mm Glass)
SECTION NO. : 992036
Weight / Mtr : 0.193

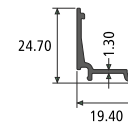

DGU CLIP (upto 38mm Glass)
SECTION NO. : 914868
Weight / Mtr : 0.185

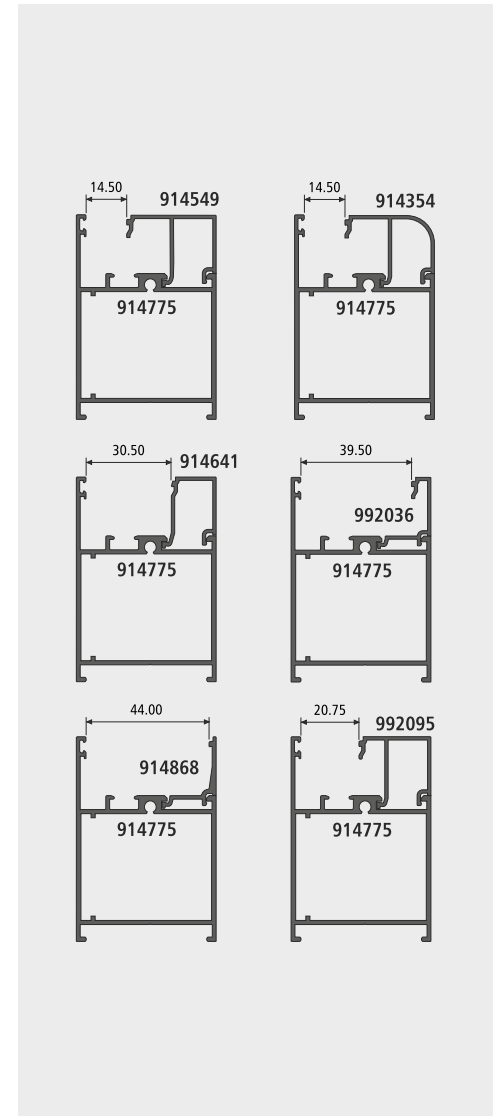

VARIOUS CLIP DETAILS

50mm CASEMENT DOOR (DGU GLASS INSIDE OPENABLE)

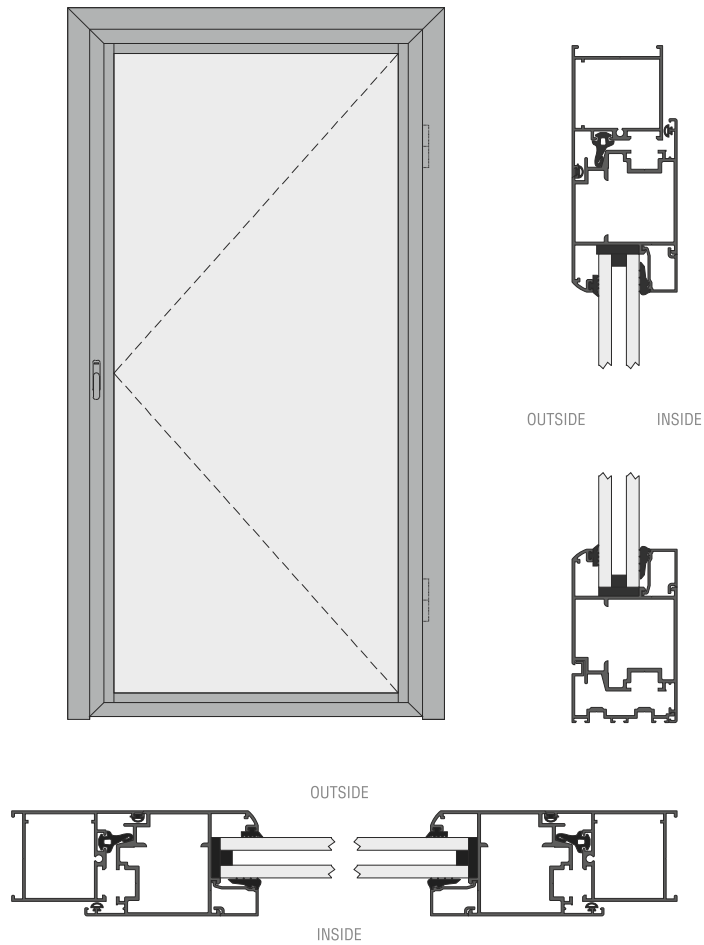

50mm CASEMENT DOOR (SGU GLASS OUTSIDE OPENABLE)

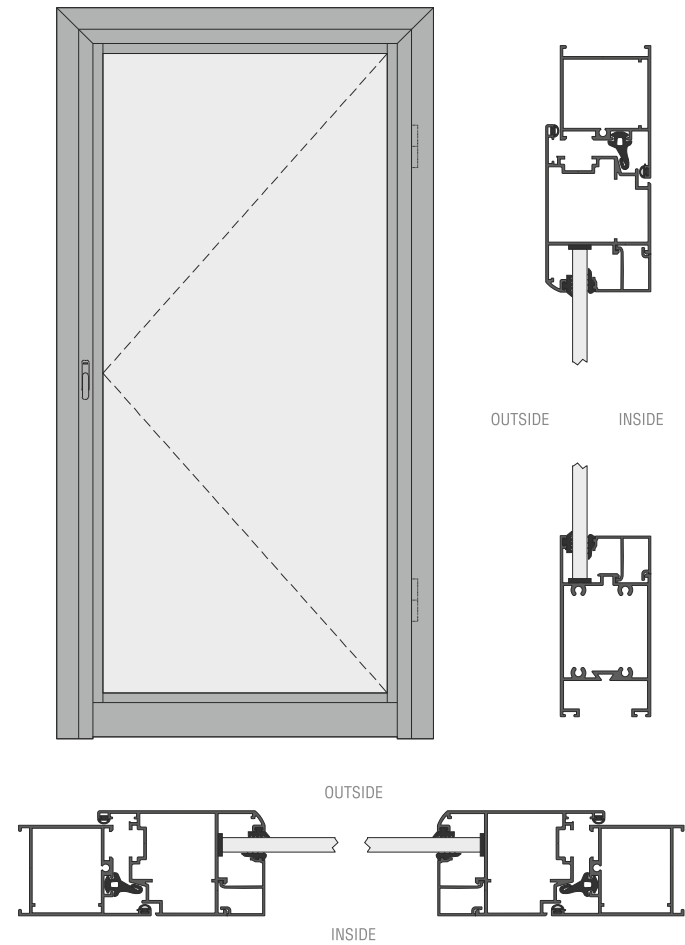

50mm CASEMENT DOUBLE DOOR (DGU GLASS OUTSIDE OPENABLE)

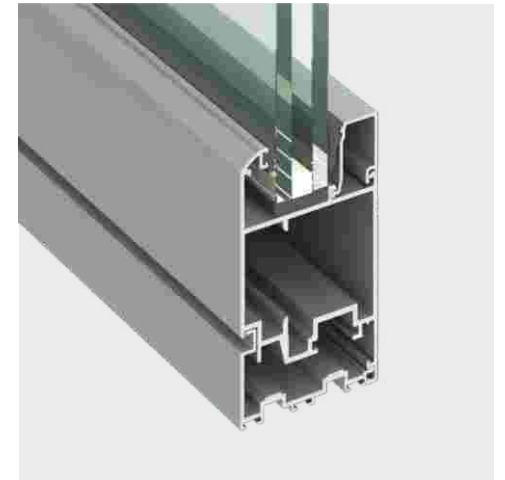
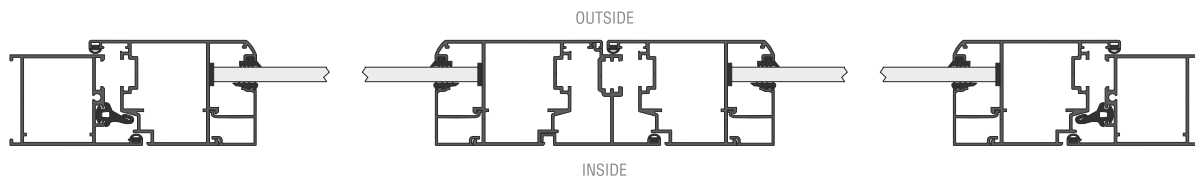
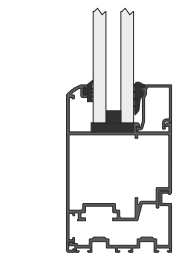
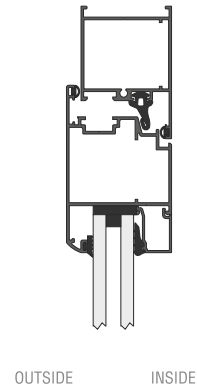
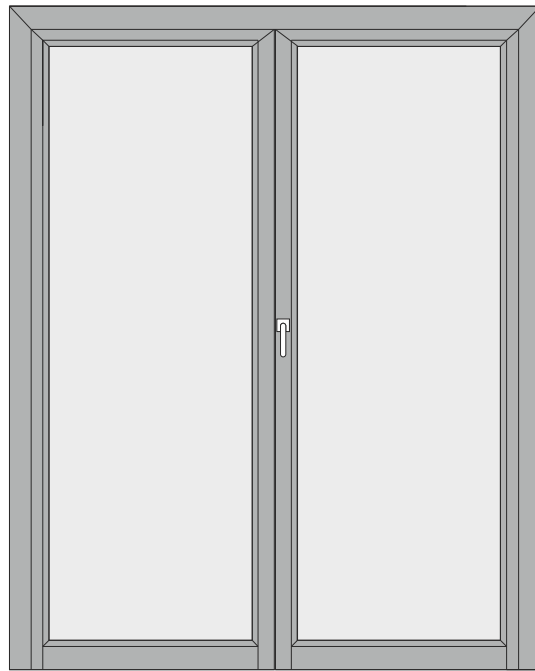

WITH DOOR BOTTOM ADAPTOR

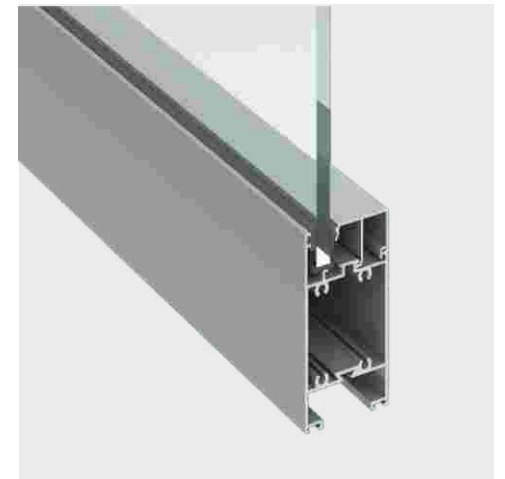

WITH DOOR BOTTOM



PIVOT WINDOWS

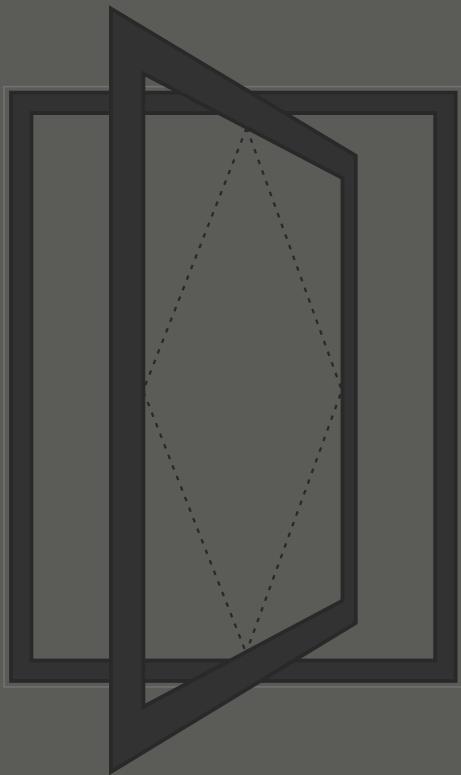

PIVOT WINDOWS

Pivot windows offer a solution for openings which have a constraint of space or for just pure aesthetics. The sash opens 90° to 180°, either vertically or horizontally. Designed around world class hardware. These windows however cannot be equipped with filter screens

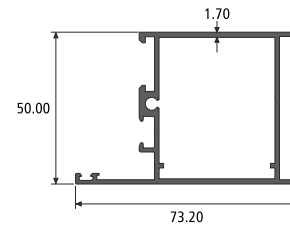
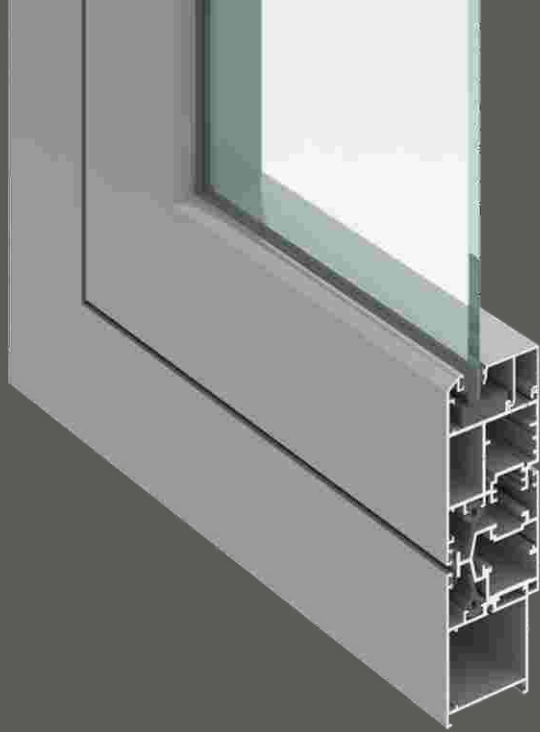

FRAME
SECTION NO. : 914775
Weight / Mtr : 1.080

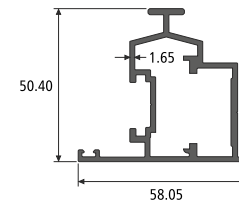

ADAPTOR
SECTION NO. : 992165
Weight / Mtr : 1.072

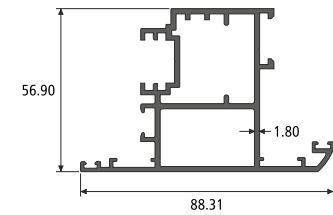

SHUTTER
SECTION NO. : 992166
Weight / Mtr : 1.623

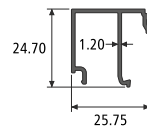

LAMINATED GLASS CLIP
SECTION NO. : 992095
Weight / Mtr : 0.288

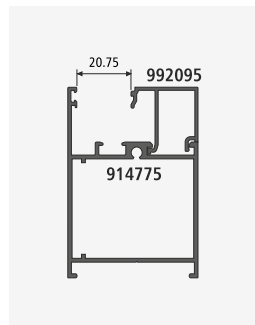

SGU CLIP
SECTION NO. : 914549
Weight / Mtr : 0.305

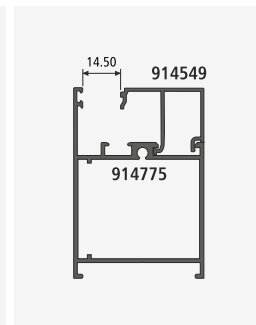

DGU CLIP
SECTION NO. : 914641
Weight / Mtr : 0.228

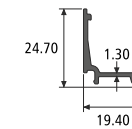

DGU CLIP
SECTION NO. : 914868
Weight / Mtr : 0.185

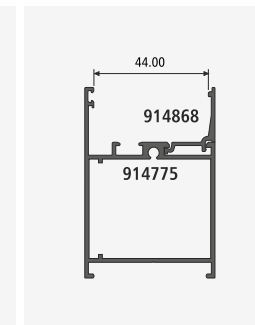

DGU CLIP
SECTION NO. : 992036
Weight / Mtr : 0.193

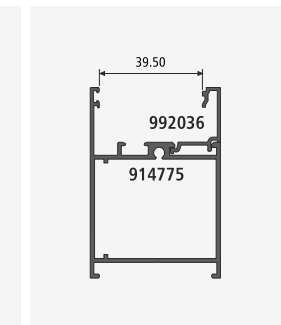

PIVOT WINDOWS

FEATURES

Frame Depth	: 50mm
Locking Type	: Multipoint Lock with Handle
Glass Range	: 5 mm to 38mm
Openable Sight Line	: 166.50 mm
Fix Sight Line	: 74 mm
Corner Details	: 45 degree cut with corner connector
Sealing Overlap	: 6 mm (Sealing with Gasket)
Window Height (Max.)	: 2200 mm
Window Width (Max.)	: 1600 mm
Window Weight (Max.)	: 100 Kg. (Aluminium+Glass)
Hardware	: SCHLEGEL GIESSE

VERTICAL (OPEN IN) PIVOT WINDOW

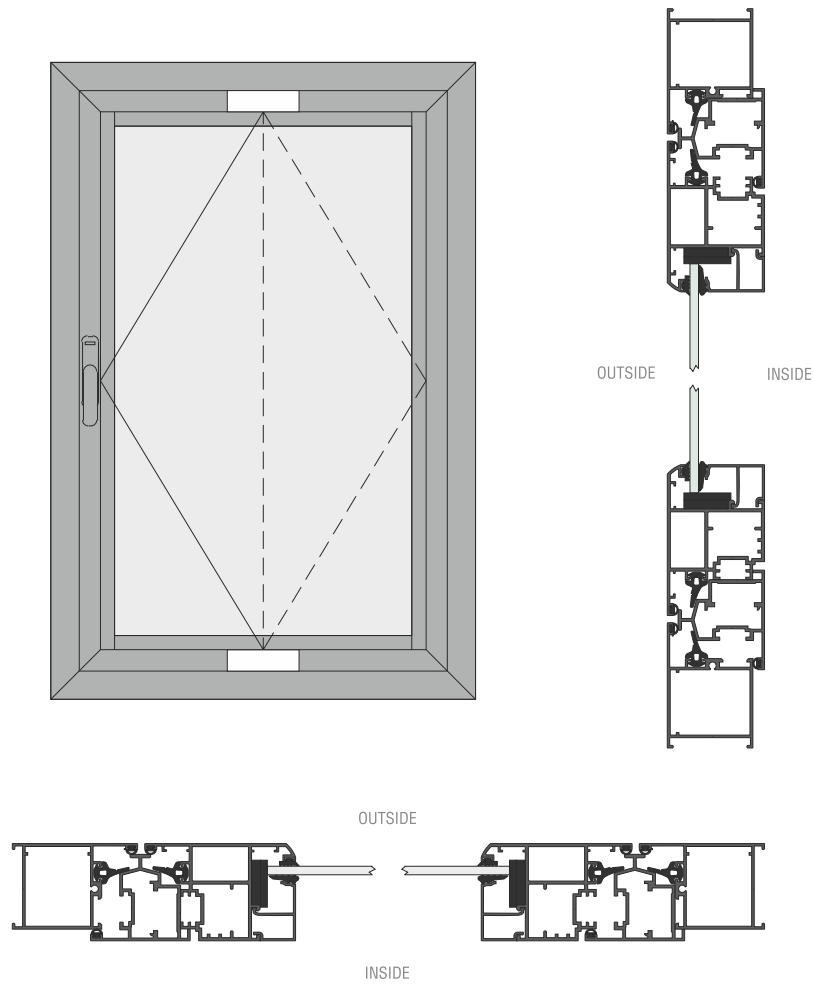

HORIZONTAL (OPEN OUT) PIVOT WINDOW

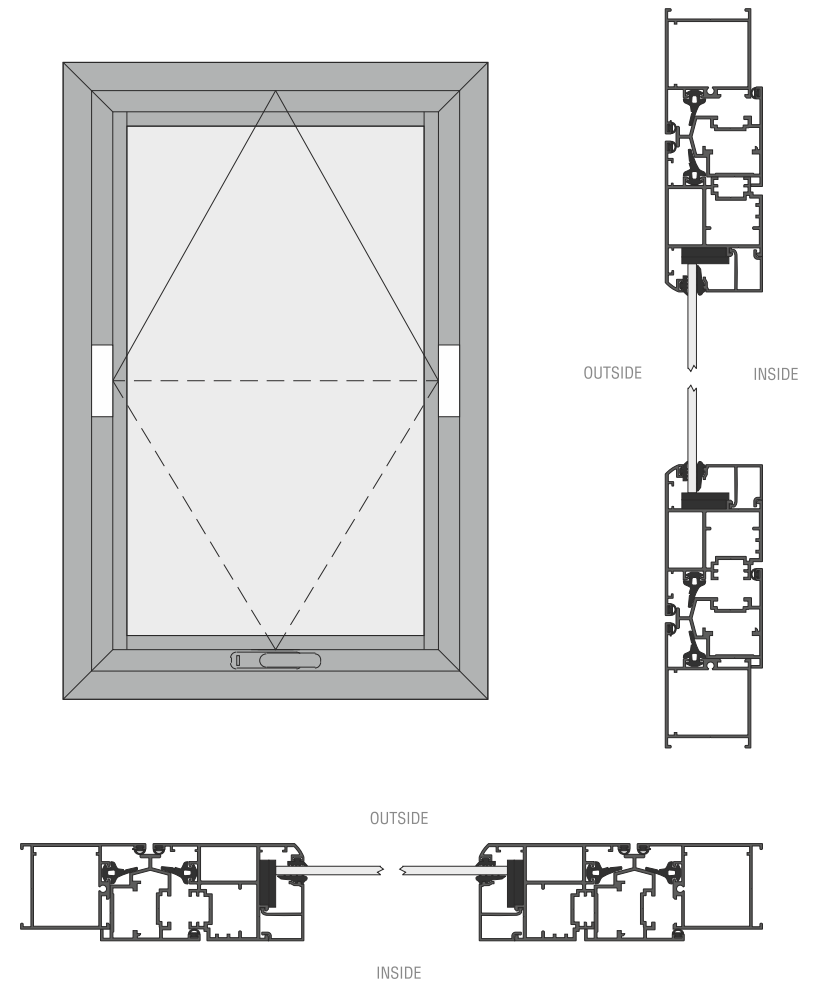

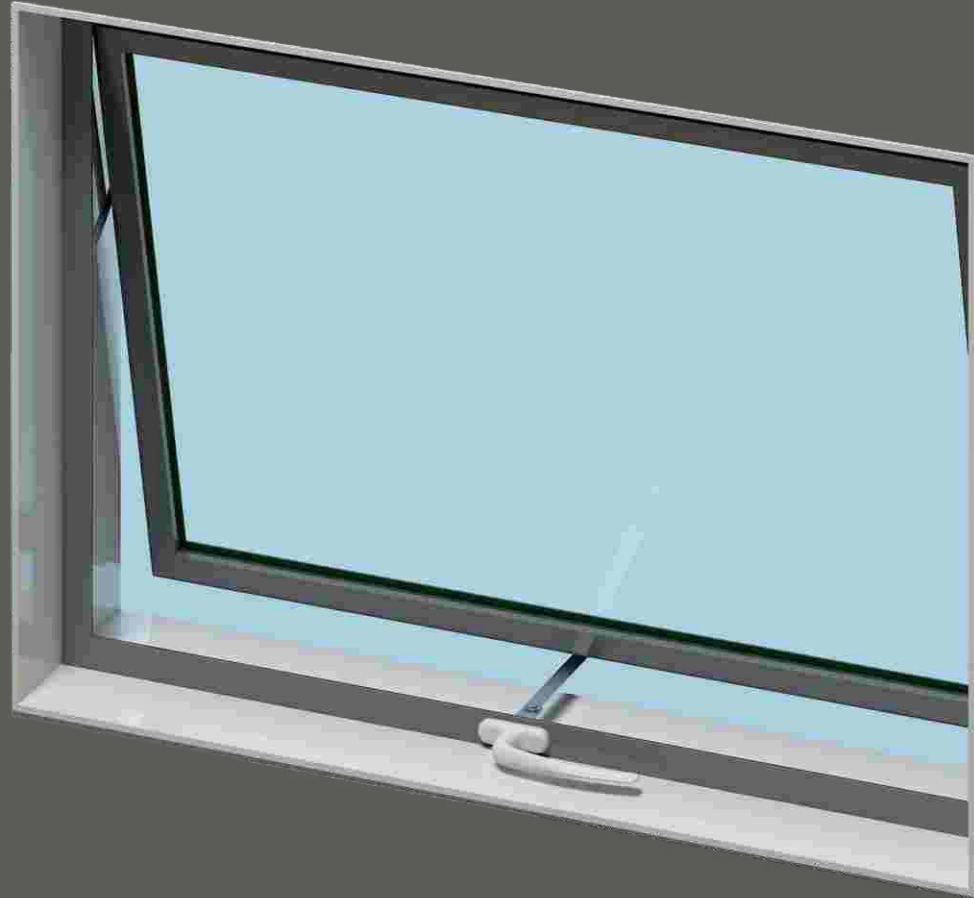

O.S. OPERATORS

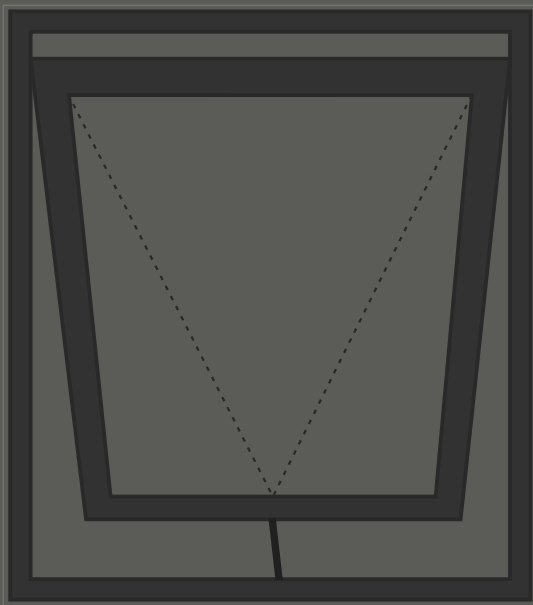

O.S. OPERATOR 2.0

OS Operator for outswing windows offer three options with one solution. Having a screen, limiting the opening and having multiple lock points for better insulation, security and lessening the air/wind/water penetration. Our design is compatible with small openings well.

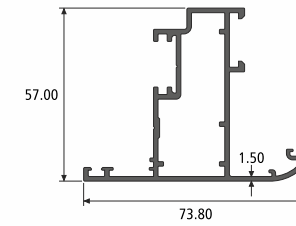
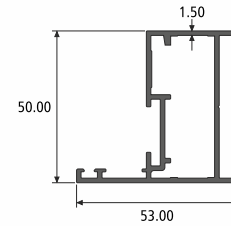
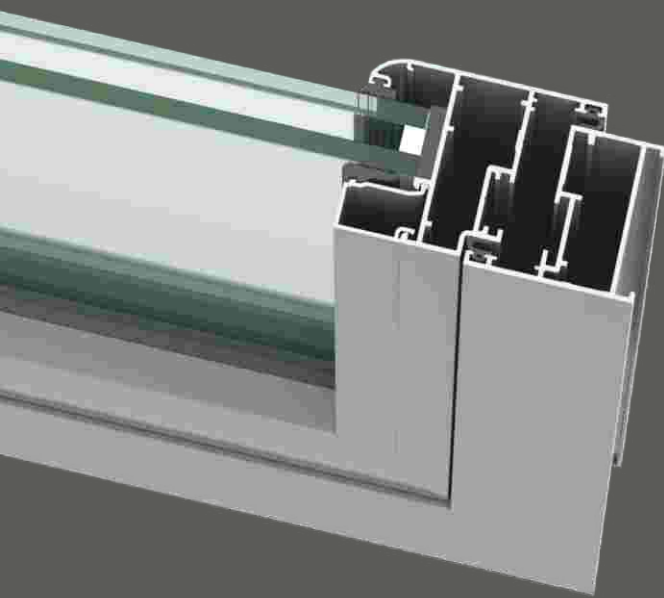

FRAME
SECTION NO. : 992177
Weight / Mtr : 0.882

SHUTTER
SECTION NO. : 992178
Weight / Mtr : 1.100

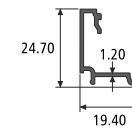
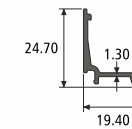
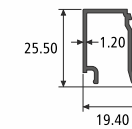
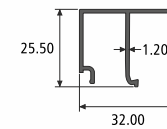
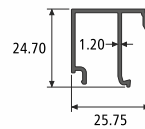

LAMINATED GLASS CLIP
SECTION NO. : 992095
Weight / Mtr : 0.288

SGU CLIP
SECTION NO. : 914549
Weight / Mtr : 0.305

DGU CLIP
SECTION NO. : 914641
Weight / Mtr : 0.230

DGU CLIP
SECTION NO. : 914868
Weight / Mtr : 0.185

DGU CLIP
SECTION NO. : 992036
Weight / Mtr : 0.193

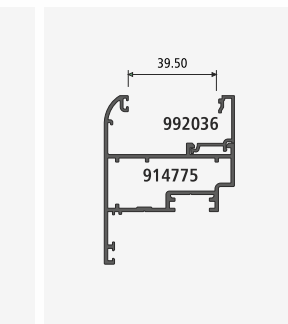
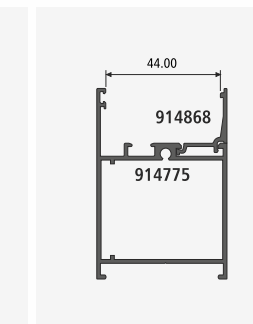
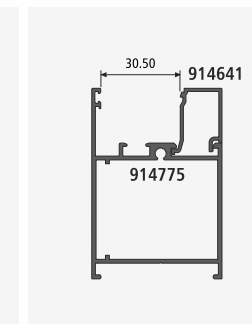
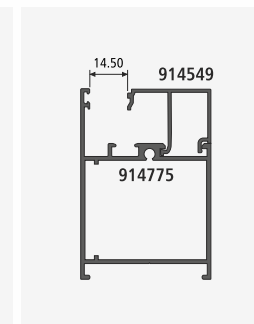
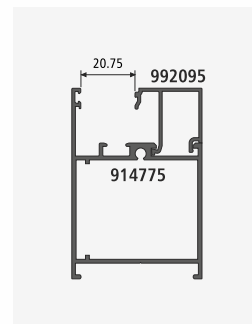

O.S.
OPERATOR 2.0

FEATURES

Frame Depth	: 50mm
Locking Type	: Single&Multipoint Lock with Handle
Glass Range	: 5 mm to 38mm
Openable Sight Line	: 97.8 mm
Fix Sight Line	: NA
Corner Details	: 45 degree cut with corner connector
Sealing Overlap	: 6mm (Sealing with Gasket)
Window Height (Max.)	: 2100 mm
Hardware	: SCHLEGEL GIESSE

O.S. OPERATOR TOP HUNG WINDOW

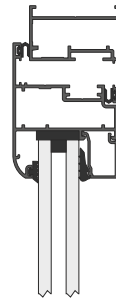
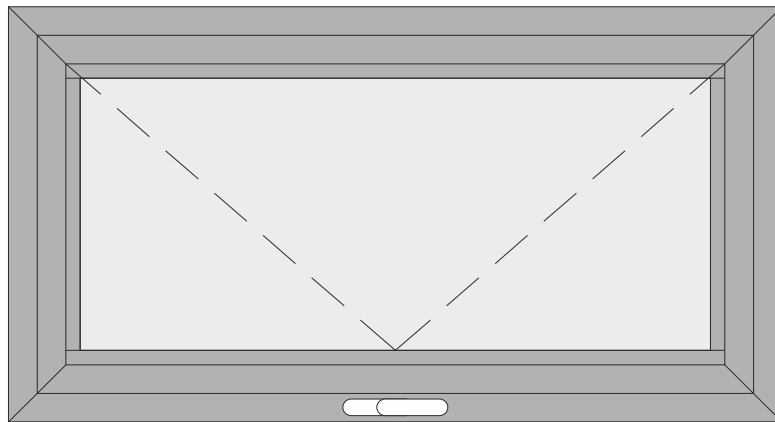

OUTSIDE INSIDE

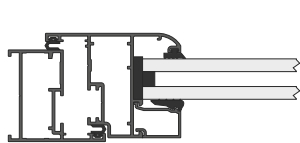
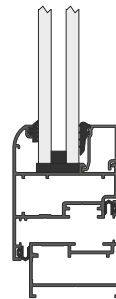

OUTSIDE

INSIDE

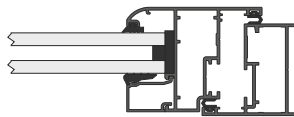

O.S. OPERATOR SIDE HUNG WINDOW

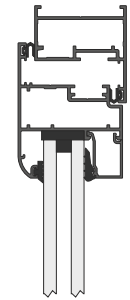
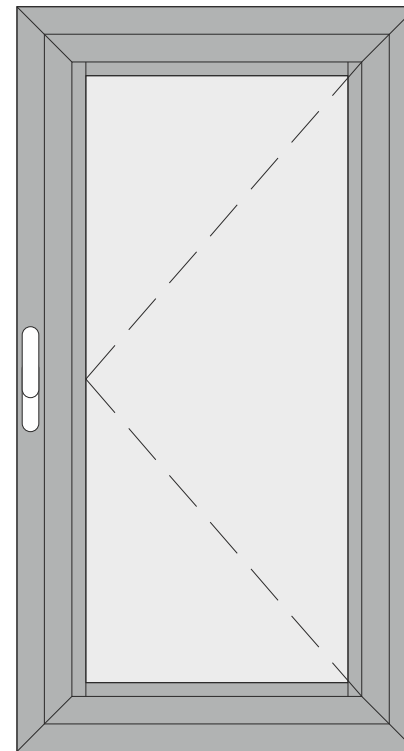

OUTSIDE INSIDE

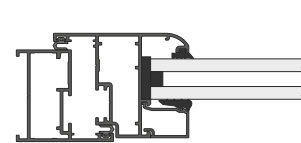
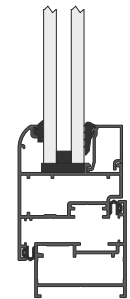

OUTSIDE

INSIDE

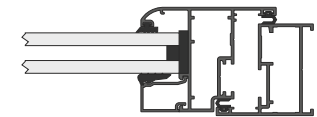



SPACEWIN®
Elegancy at its extreme!!

TILT & SLIDE WINDOWS

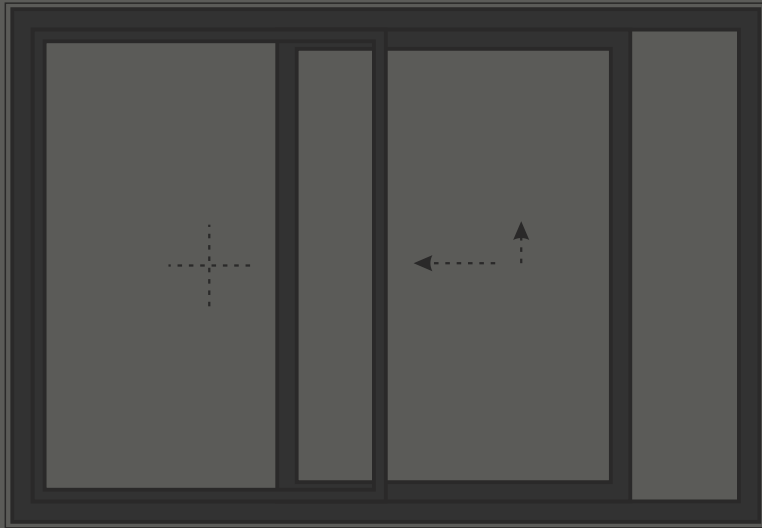

TILT & SLIDE WINDOWS

Tilt and Slide windows are a twist on conventional slider windows. Both sashes slide independently and also offer a tilt option for providing ventilation while controlling access thus providing enhanced security.

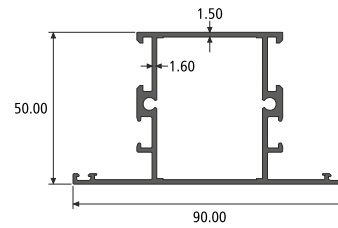
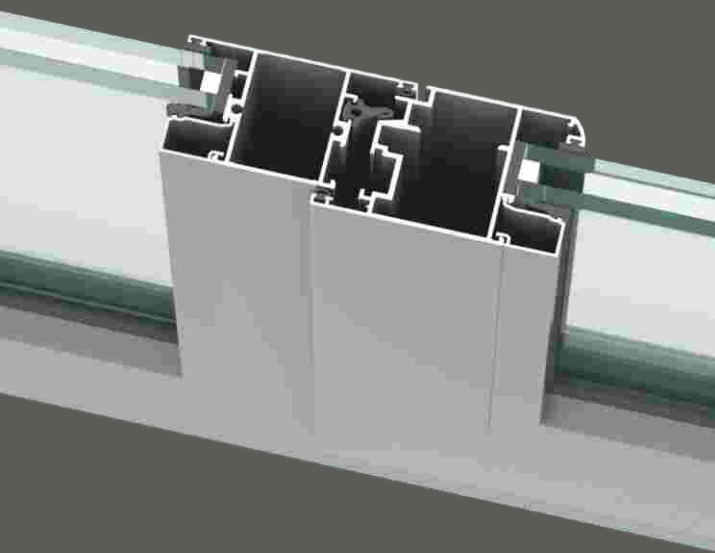

MULLION
SECTION NO. : 914774
Weight / Mtr : 1.235

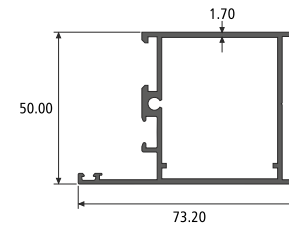

FRAME
SECTION NO. : 914775
Weight / Mtr : 1.080

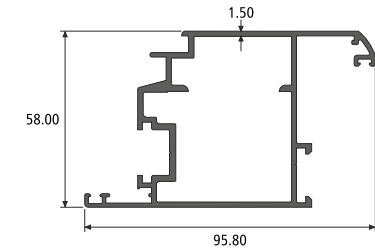

INSIDE OP. SHUTTER
SECTION NO. : 992109
Weight / Mtr : 1.540

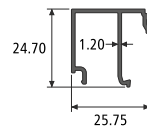

LAMINATED GLASS CLIP
SECTION NO. : 992095
Weight / Mtr : 0.288

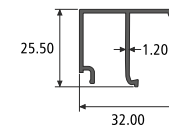

SGU CLIP
SECTION NO. : 914549
Weight / Mtr : 0.305

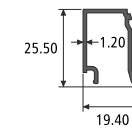

DGU CLIP
SECTION NO. : 914641
Weight / Mtr : 0.230

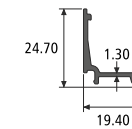

DGU CLIP
SECTION NO. : 914868
Weight / Mtr : 0.185

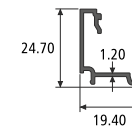

DGU CLIP
SECTION NO. : 992036
Weight / Mtr : 0.193

TILT & SLIDE
WINDOWS

FEATURES

Frame Depth	: 50mm
Locking Type	: Single&Multipoint Lock with Handle
Glass Range	: 5 mm to 38mm
Openable Sight Line	: 142 mm
Fix Sight Line	: 74 mm
Corner Details	: 45 degree cut with corner connector
Sealing Overlap	: 6mm (Sealing with Gasket)
Window Height (Max.)	: 2440 mm
Hardware	: SCHLEGEL GIESSE

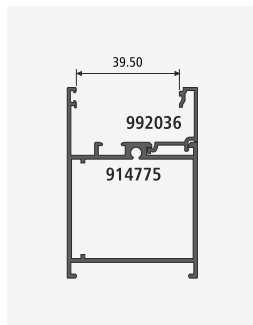
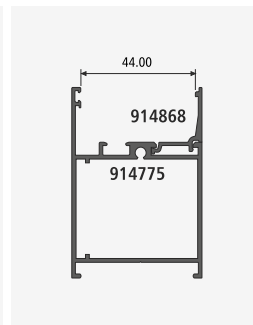
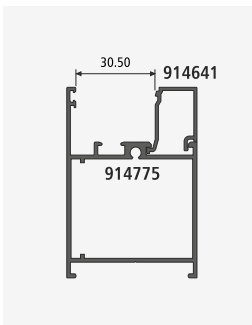
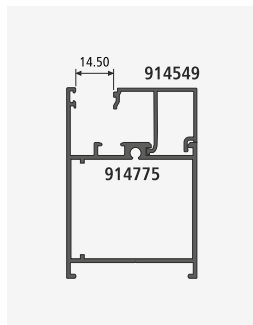
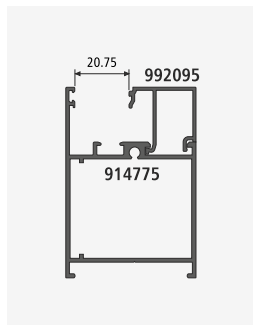

TILT & SLIDE WINDOW

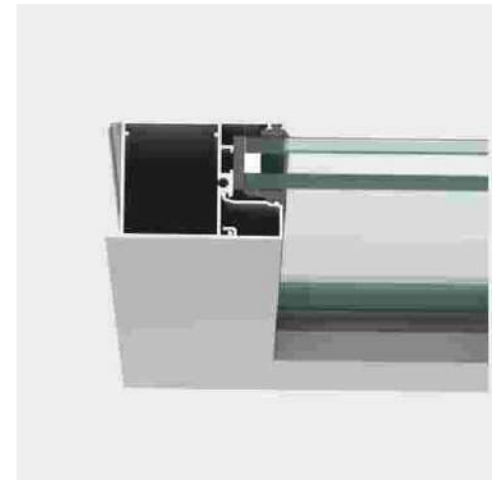
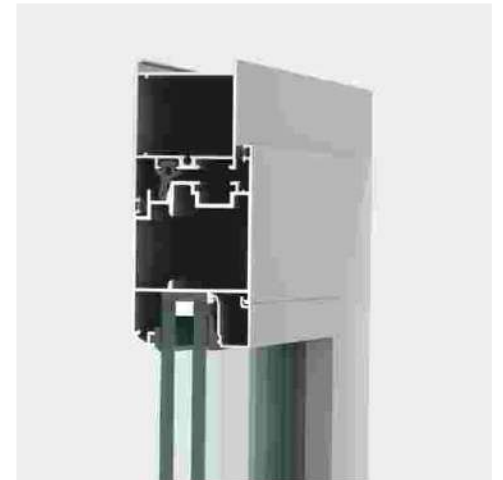
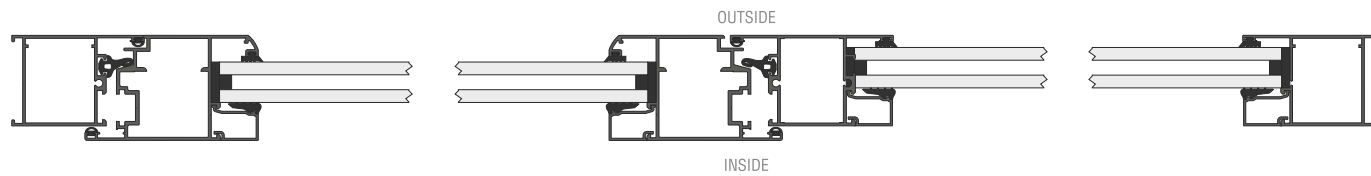
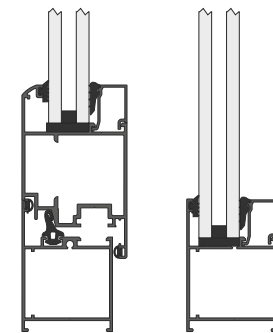
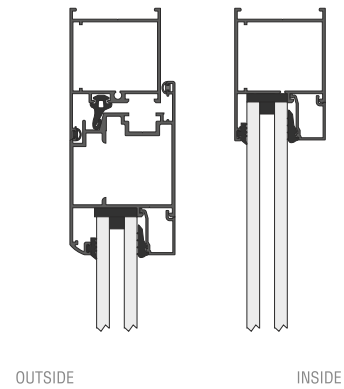
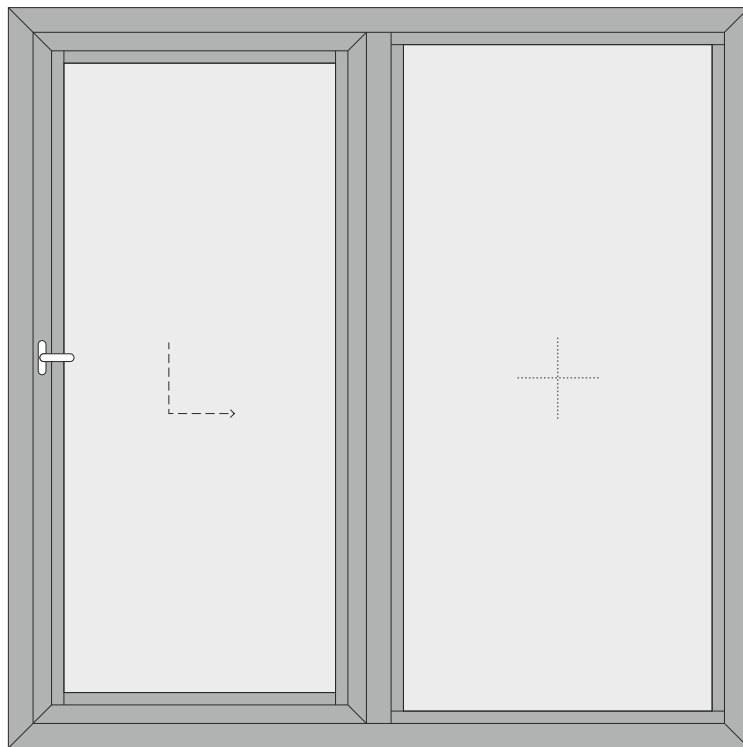

SPACEWIN®
Elegancy at its extreme!!



TILT & TURN WINDOWS

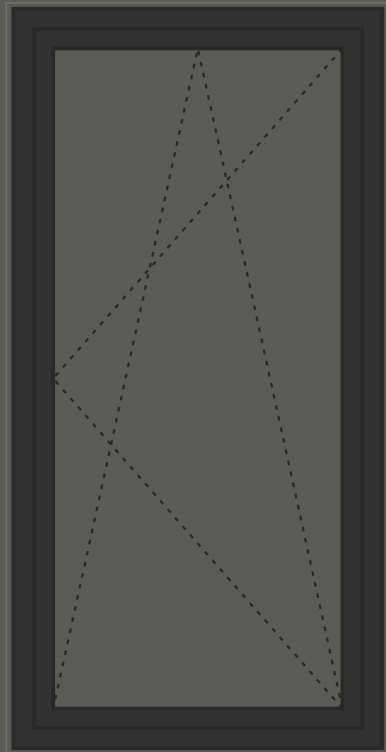

TILT & TURN WINDOWS

Tilt and Turn windows offer great flexibility to our more discerning clients. It offers full opening akin to casement windows for needs of cleaning and greater access. It also offers greater security by allowing superb ventilation using the tilt option and yet not allowing full access. It has better insulation characteristics than sliding options as well.

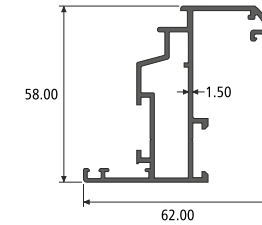
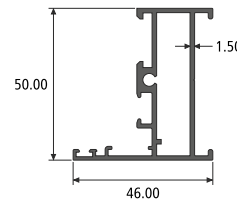
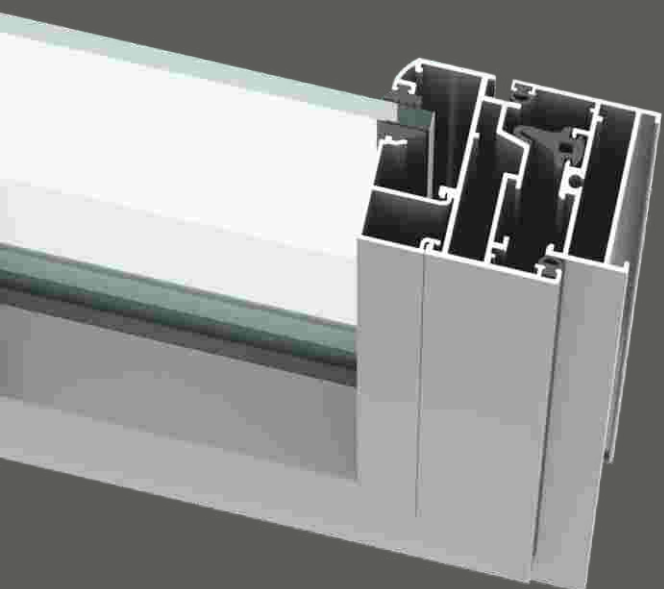

FRAME
SECTION NO. : 914351
Weight / Mtr : 0.818

INSIDE OP. SHUTTER
SECTION NO. : 914520
Weight / Mtr : 0.955

TILT&TURN
WINDOWS

FEATURES

Frame Depth	: 50 mm
Locking Type	: Single&Multipoint Lock with Handle
Glass Range	: 5 mm to 38mm
Openable Sight Line	: 81.0mm
Fix Sight Line	: 46 mm
Corner Details	: 45 degree cut with corner connector
Sealing Overlap	: 6mm (Sealing with Gasket)
Window Height (Max.)	: 1800 mm
Hardware	: SCHLEGEL GIESSE

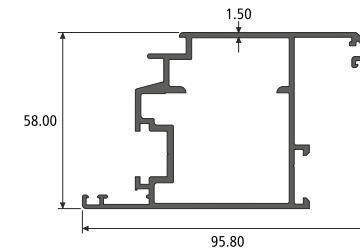
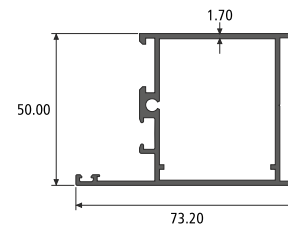

FRAME
SECTION NO. : 914775
Weight / Mtr : 1.080

INSIDE OP. SHUTTER
SECTION NO. : 992109
Weight / Mtr : 1.540

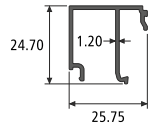

LAMINATED GLASS CLIP
SECTION NO. : 992095
Weight / Mtr : 0.288

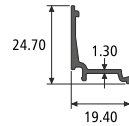

DGU CLIP
SECTION NO. : 914868
Weight / Mtr : 0.185

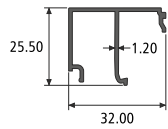

SGU CLIP
SECTION NO. : 914549
Weight / Mtr : 0.305

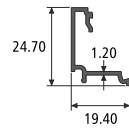

DGU CLIP
SECTION NO. : 992036
Weight / Mtr : 0.193

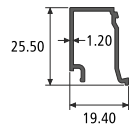

DGU CLIP
SECTION NO. : 914641
Weight / Mtr : 0.228

TILT & TURN WINDOW

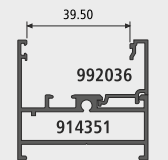
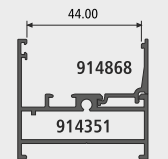
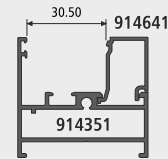
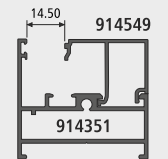
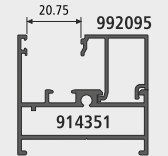
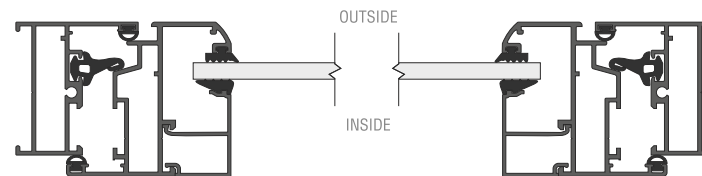
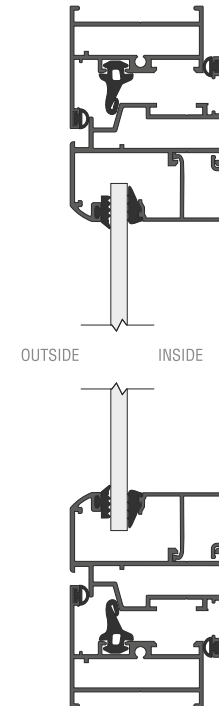
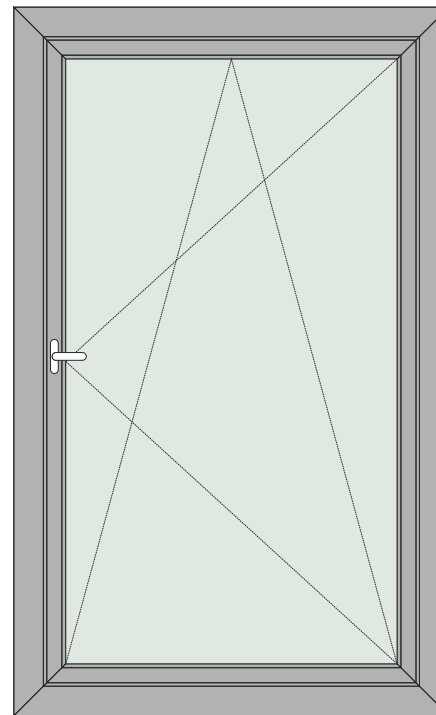

VARIOUS CLIP DETAILS

SPACEWIN®
Elegancy at its extreme!!

CURTAIN WALL



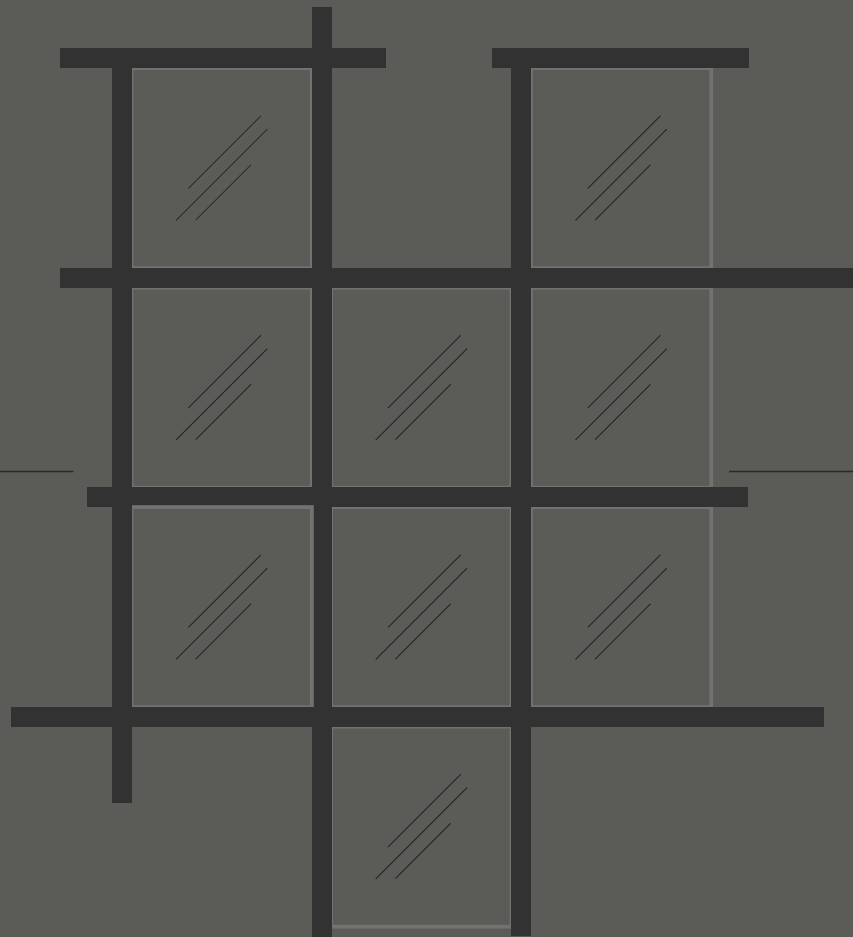

CURTAIN WALL

Curtain Wall systems. Our systems offer greater flexibility for mating different size profiles. Fully compatible opening options like ventilators and other openings are given, enhancing utility without compromising on the aesthetics. Both SGU and DGU options with world class hardware offer high weather and wind resistance for the system. Higher Glass to frame ratios offer full visibility without compromising on the design characteristics.

45mm | 50mm | 57mm

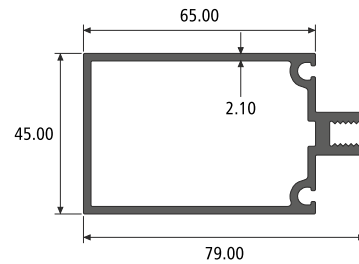

MULLION / TRANSOM
SECTION NO. : 914160
Weight / Mtr : 1.514

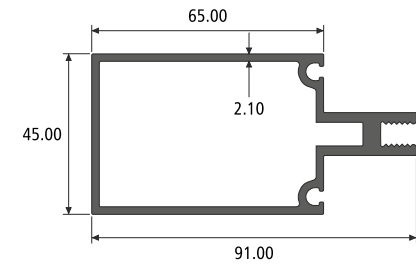

MULLION / TRANSOM
SECTION NO. : 914171
Weight / Mtr : 1.708

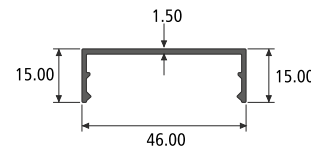

COVER CAP
SECTION NO. : 957035
Weight / Mtr : 0.293

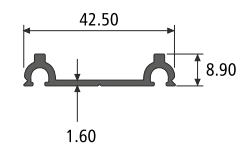

PRESSURE PLATE
SECTION NO. : 914104
Weight / Mtr : 0.300

45mm
CURTAIN WALL

FEATURES

- Mullion / Transom Depth : 45 mm
- Glass Range : 5 mm to 20mm
- Window Height (Max.) : 2440 mm

45mm CURTAIN WALL

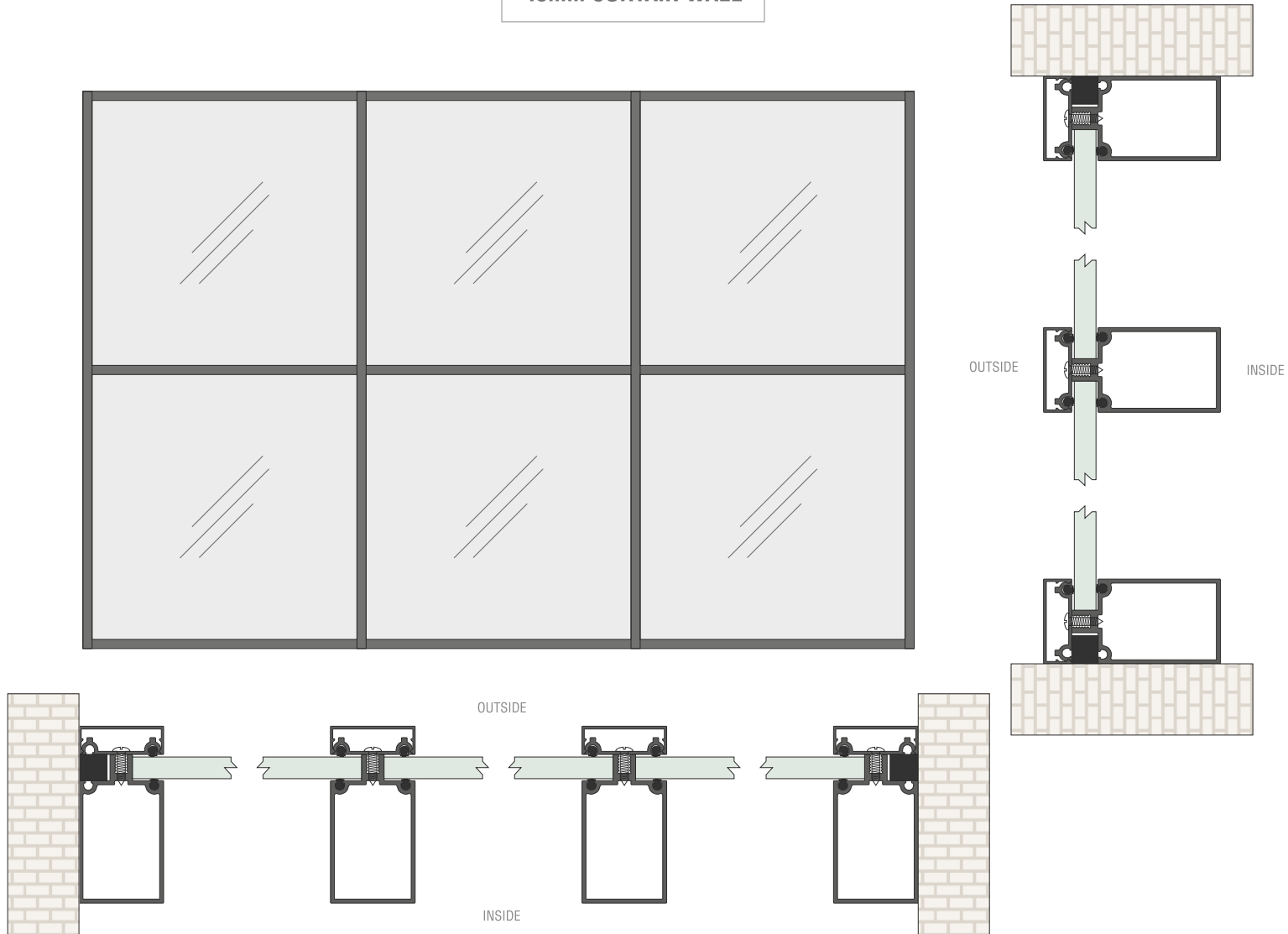

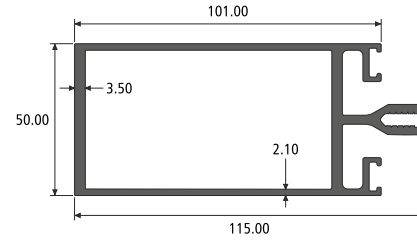
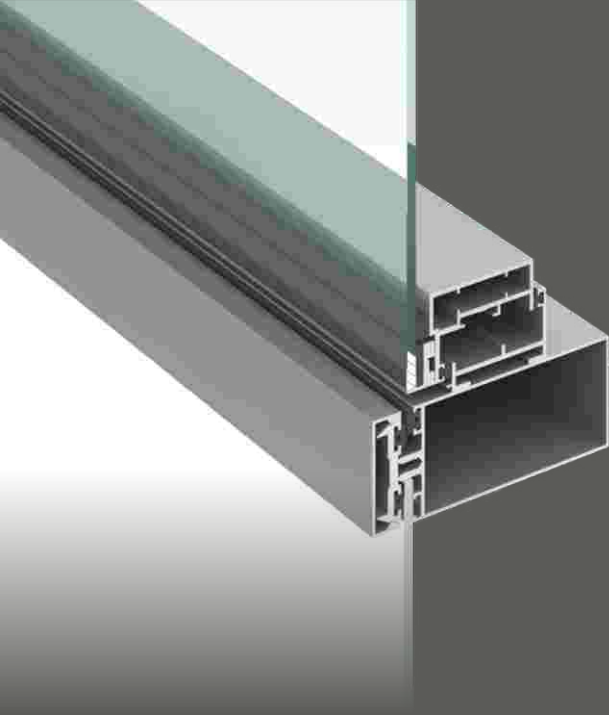

MULLION
SECTION NO. : 551038
Weight / Mtr : 2.505

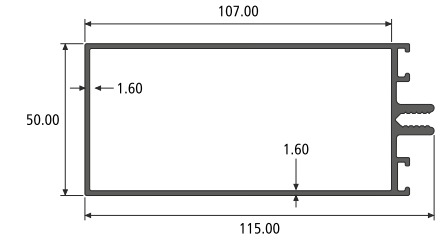

TRANSOM
SECTION NO. : 551037
Weight / Mtr : 1.596

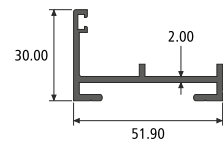

FRAME
SECTION NO. : 992098
Weight / Mtr : 0.616

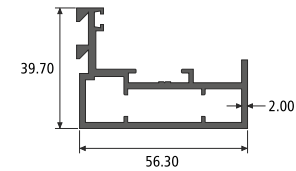

SHUTTER
SECTION NO. : 992097
Weight / Mtr : 1.106

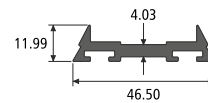

PRESSURE PLATE
SECTION NO. : 551041
Weight / Mtr : 0.564

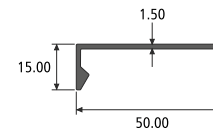

COVER PLATE
SECTION NO. : 551042
Weight / Mtr : 0.365

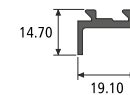

GLASS SUPPORT
SECTION NO. : 992099
Weight / Mtr : 0.219

50mm
CURTAIN WALL

FEATURES

Mullion / Transom Depth	: 50 mm
Glass Range	: 5 mm to 24mm
Window Height (Max.)	: 3010 mm
Hardware	: SCHLEGEL GIESSE

50mm CURTAIN WALL

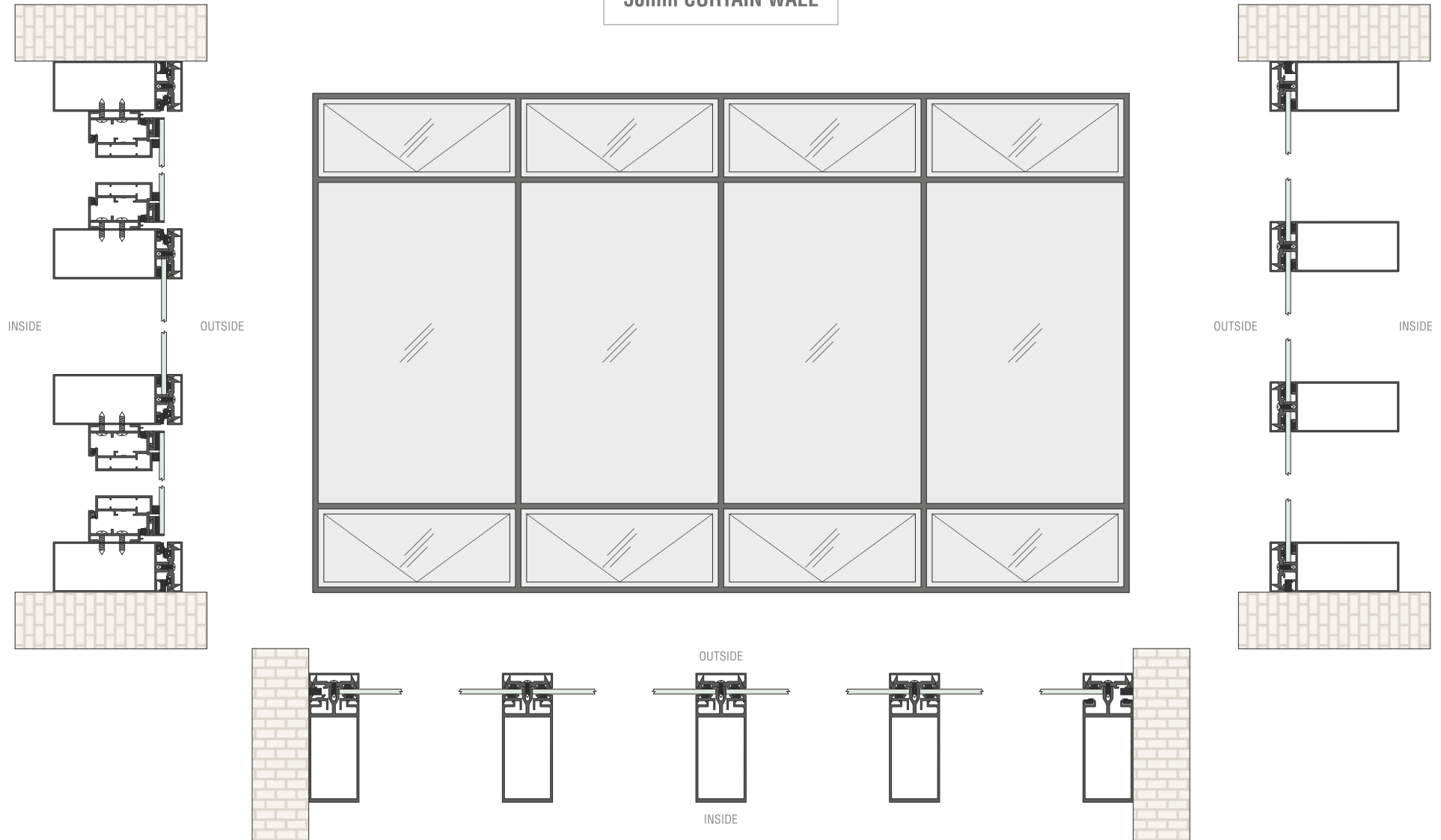

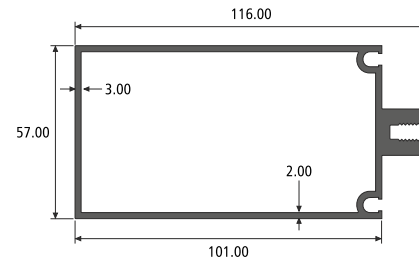
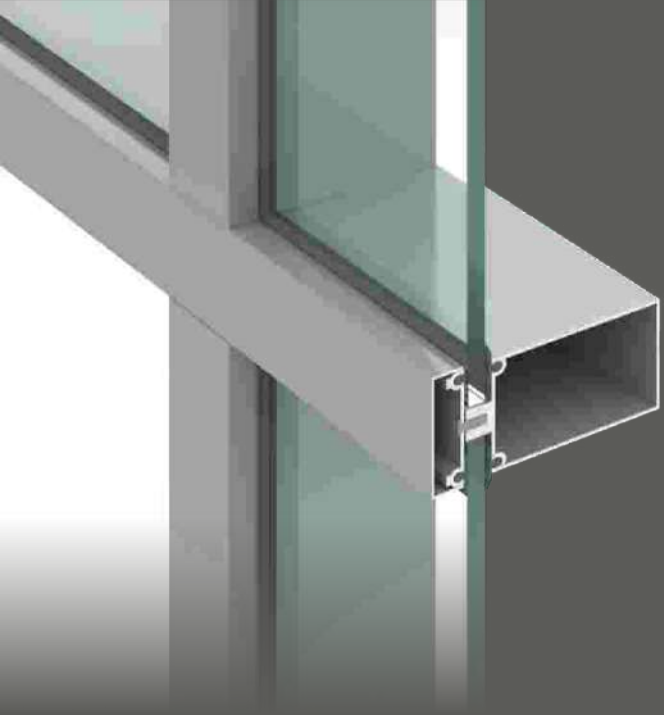

MULLION
SECTION NO. : 551026
Weight / Mtr : 2.173

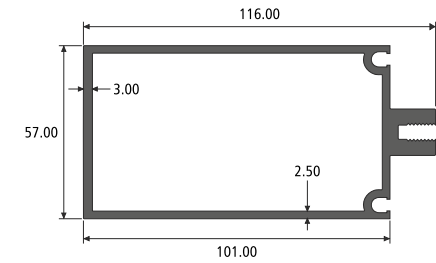

MULLION
SECTION NO. : 551027
Weight / Mtr : 2.641

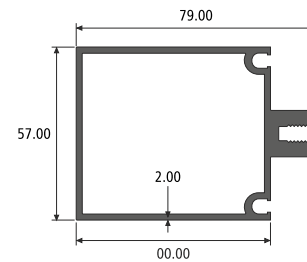

TRANSOM
SECTION NO. : 812957
Weight / Mtr : 1.787

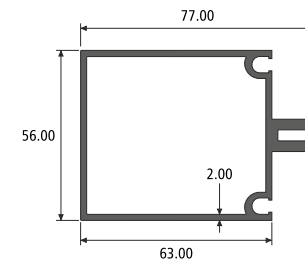

TRANSOM
SECTION NO. : 812958
Weight / Mtr : 1.591

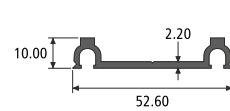

PRESSURE PLATE
SECTION NO. : 812959
Weight / Mtr : 0.439

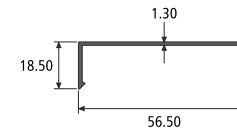

COVER CAP
SECTION NO. : 812960
Weight / Mtr : 0.321

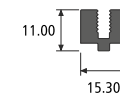

ADAPTOR
SECTION NO. : 992090
Weight / Mtr : 0.372

57mm
CURTAIN WALL

FEATURES

Mullion / Transom Depth	: 57 mm
Glass Range	: 5 mm to 20 mm
Window Height (Max.)	: 2440 mm

57mm CURTAIN WALL

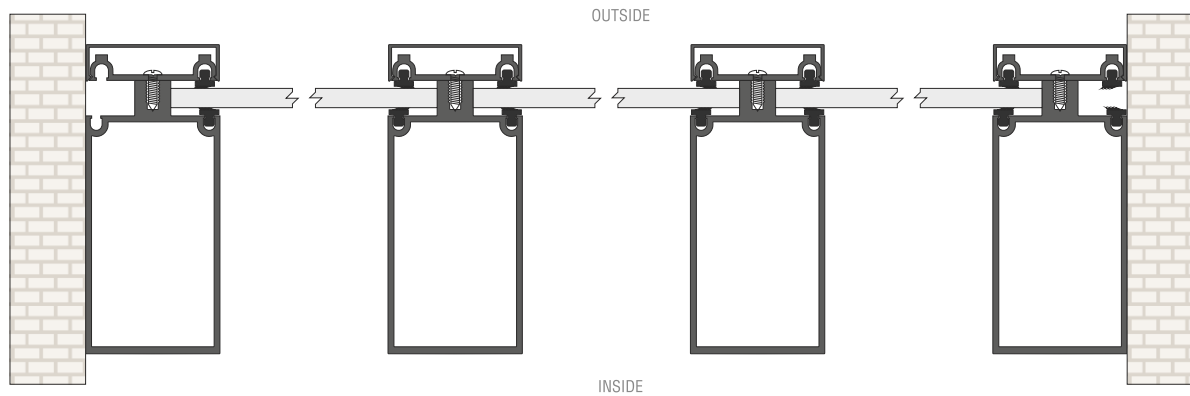
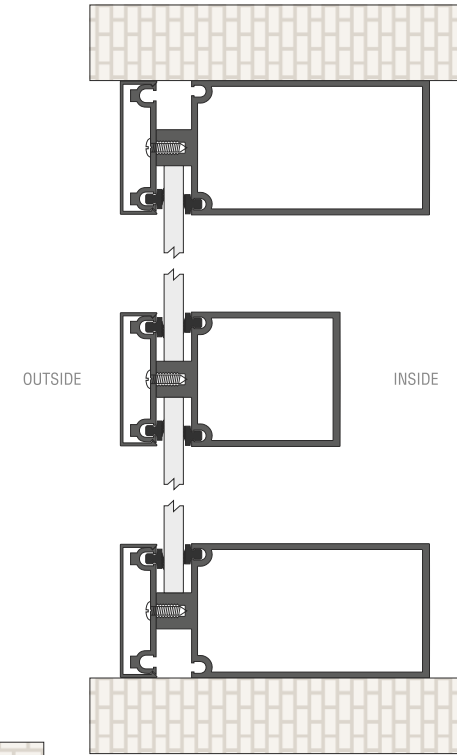
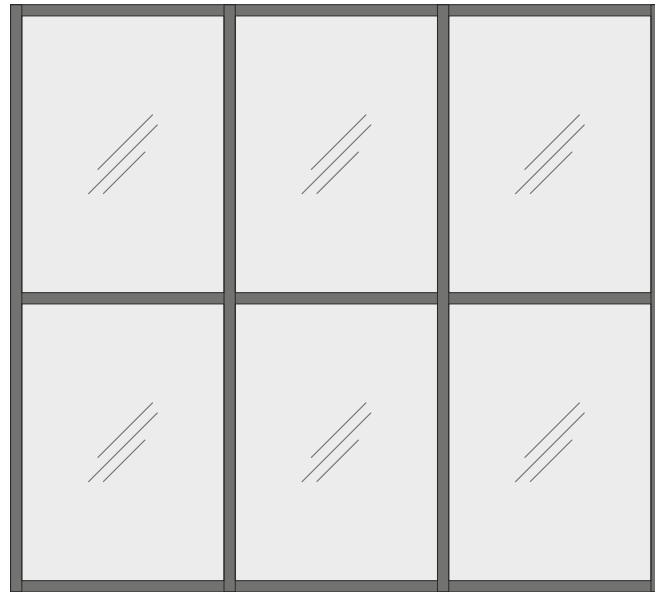



SPACEWIN®
Elegancy at its extreme!!

**SEMI
UNITIZED**



SEMI UNITIZED

Semi-Unitized Glazing systems offer more flexibility to the fabricators to assemble a large part of their curtain walls off site thereby saving time and cost. They also provide a greater structural efficiency than traditional curtain walls there by reducing the cost further without compromising on glass to frame ratios.



MULLION
SECTION NO. : 551060
Weight / Mtr : 3.411

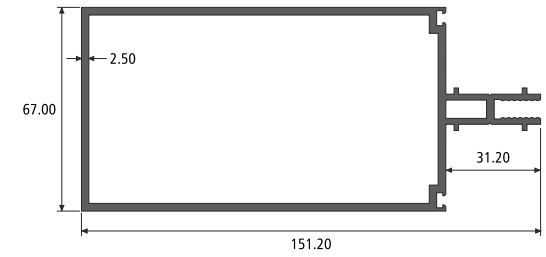

MULLION
SECTION NO. : 551010
Weight / Mtr : 2.896

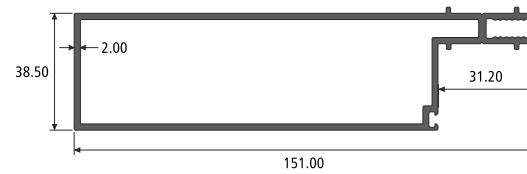

HALF MULLION
SECTION NO. : 551012
Weight / Mtr : 2.061

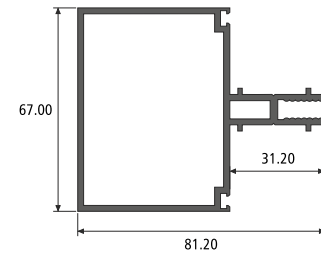

TRANSOM
SECTION NO. : 551011
Weight / Mtr : 1.659

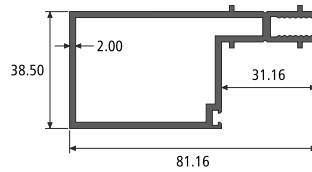

HALF TRANSOM
SECTION NO. : 819503
Weight / Mtr : 1.294

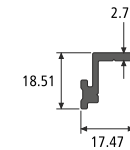

TOGGLE
SECTION NO. : 968039
Weight / Mtr : 0.240

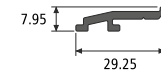

TOGGLE
SECTION NO. : 992004
Weight / Mtr : 0.230

67mm
SEMI UNITIZED

FEATURES

- Mullion / Transom Depth : 67 mm
- Glass Range : 5 mm to 24mm
- Window Height (Max.) : 3010 mm
- Hardware : SCHLEGEL GIESSE

67mm SEMIUNITIZED WALL

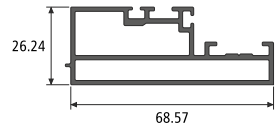

SGU SASH
SECTION NO. : 967053
Weight / Mtr : 1.020

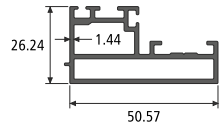

DGU SASH
SECTION NO. : 967054
Weight / Mtr : 0.792

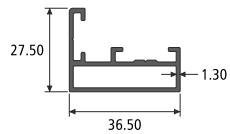

SASH
SECTION NO. : 992003
Weight / Mtr : 0.470

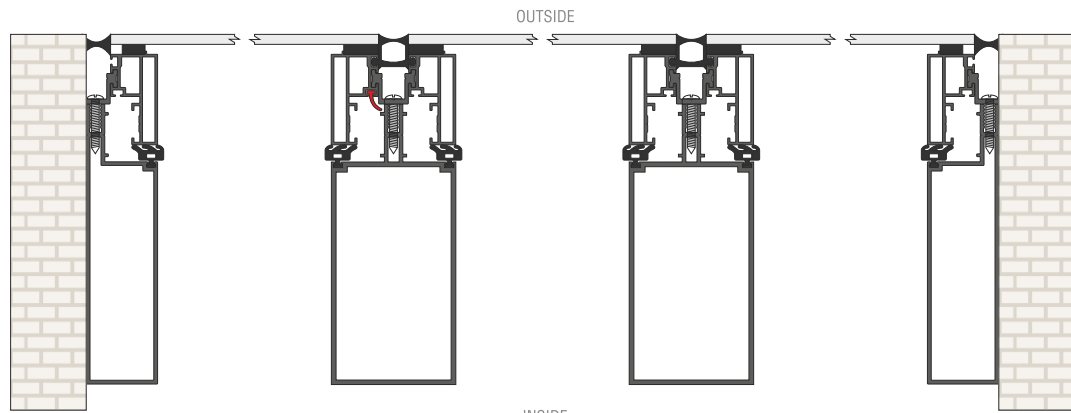
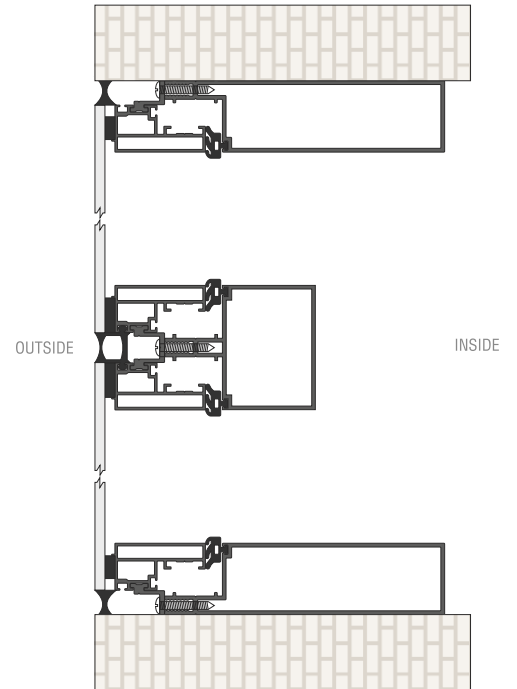

SPACERAIL®
AN EPITOME OF RAILINGS

MODEL NO.

ALPS-01
GLASS PARTITION SYSTEM



MODEL NO.

ALPS-01
GLASS PARTITION SYSTEM

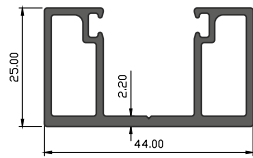

FIXED PROFILE

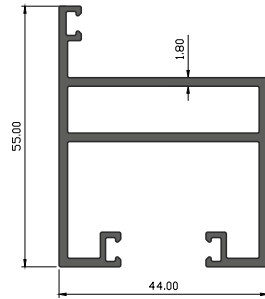

DOOR PROFILE

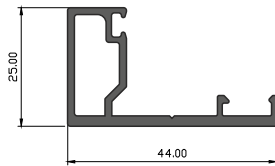

BOTTOM PROFILE

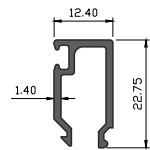

CLIP ON PROFILE

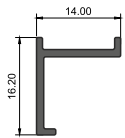

L- GLASS JOINT

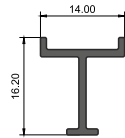

T- GLASS JOINT

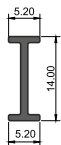

I - GLASS JOINT

45 X 25MM SINGLE GLASS PARTITION SYSTEM
GLASS THICKNESS : 10.00 mm / 12.00 mm



SPACERAIL®
AN EPITOME OF RAILINGS

MODEL NO.
ALPS-01
STILE DOOR SYSTEM



MODEL NO.

ALPS-01
STILE DOOR SYSTEM

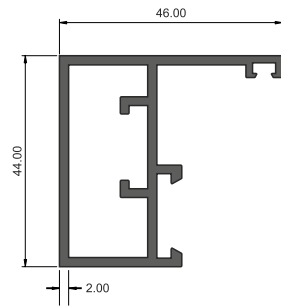

STILE DOOR - FRAME PROFILE

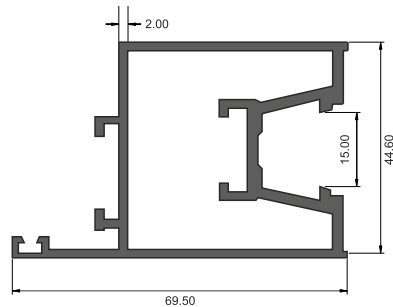

STILE DOOR - SHUTTER PROFILE

GLASS THICKNESS : 10.00 mm / 12.00 mm

00600
BRIDGE
HINGES

DOOR WEIGHT 3 HINGE
100 Kg. Max.

DOOR WEIGHT 2 HINGE
90 Kg. Max.

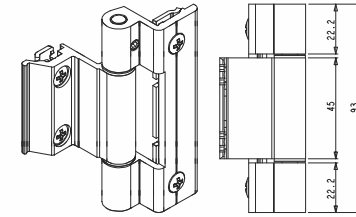

00681
CELERA XL
HINGES

DOOR WEIGHT 3 HINGE
120 Kg. Max.

DOOR WEIGHT 2 HINGE
100 Kg. Max.

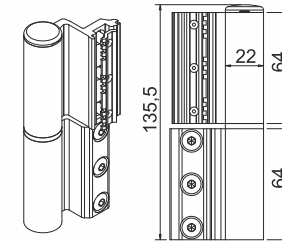

00598
FLASH XXL
HINGE

00599
COVER FOR XXL
HINGE

DOOR WEIGHT 3 HINGE
180 Kg. Max.

DOOR WEIGHT 2 HINGE
160 Kg. Max.

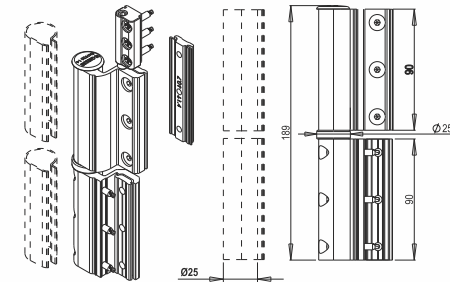

GASKET 001

GASKET 002

L - CONNECTOR

SPACERAIL®
AN EPITOME OF RAILINGS

40+
ALUMINIUM RAILING
SYSTEMS

20+
ALUMINIUM
HANDRAILS

CERTIFIED
TESTED SYSTEMS

100%
WEATHER PROOF
SYSTEMS

304 GRADE
SS MODULAR
RAILING SYSTEM

LED
SYSTEMS 
WOODEN
HANDRAILS

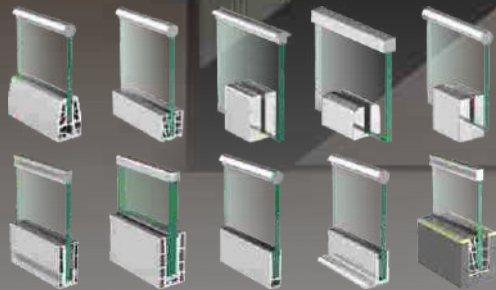

ELEGANTLY CRAFTED
ALUMINIUM &
STAINLESS STEEL
RAILING SYSTEMS



**GLASS FACADE &
CURTAIN WALL
SYSTEM**

SPACEARCH®
which brighten your world!!



SPACEBAR

WE BEAUTIFY YOUR WORLD !!

SPACEWIN[®]
Elegancy at its extreme!!

SPACERAIL[®]
AN EPITOME OF RAILINGS

SPACEARCH[®]
which brighten your world!!

SPACEBAR

WE BEAUTIFY YOUR WORLD !!

DISPLAY : 605, RUN-WAY HEIGHTS, AYODHYA CHOWK, 150 FT RING ROAD, RAJKOT-GUJARAT

UNIT 1 : VNV SYSTEM, PLOT NO 48, RK INDUSTRIAL ZONE-12, SH-113,KUVADVA-WANKANER HIGHWAY,
RAJKOT-360003(GUJARAT-INDIA)

UNIT 2 : CHANGODAR GIDC,AHMEDABAD

OFFICE 1 : 4TH FLOOR, LABH ENCLAVE, KISHANPARA CHOWK, RAJKOT

OFFICE 2 : MAKARBA, S.G.HIGHWAY, AHMEDABAD

+91 97997 60260 / 96896 32 8 32 / 8936 030303

INFO@SPACEBARGROUP.COM | WWW.SPACEBARGROUP.COM